



METRICA



delta
Pubblicità srl



ARTICOLI PROMOZIONALI

PROMOTION ITEMS | ARTICULOS DE PROMOCIÓN | ARTICLE PROMOTIONNELS | WERBWARTIKEL

METRICA

what's new

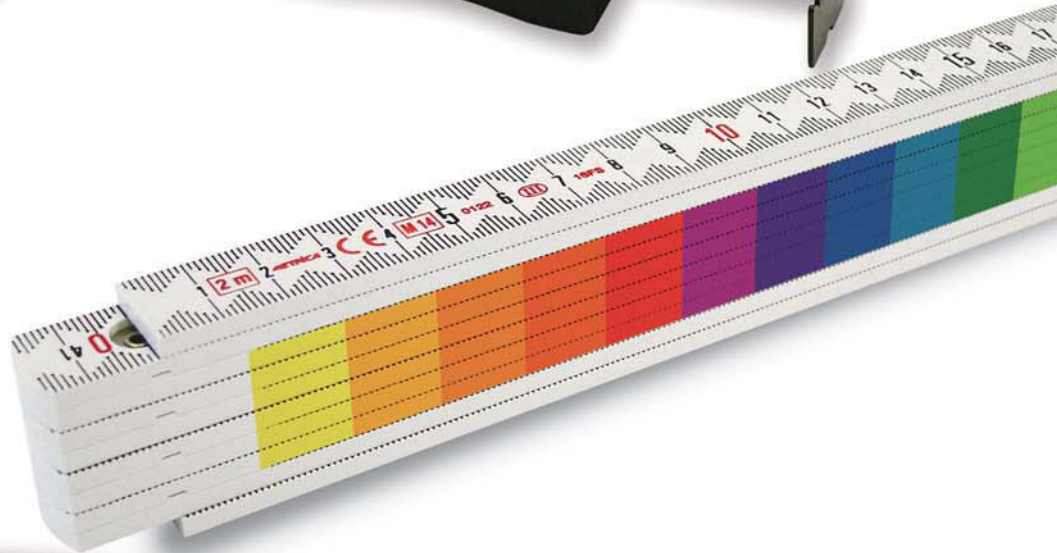

FLESSOMETRI 4

TAPE RULES | FLEXOMETROS | MÈTRES À RUBAN | ROLLBANDMAßE

METRI 18

FOLDING RULES | METROS | MÈTRES PLIANTS | MAßSTÄBE

FINGERSAFE 33**MATITE SPECIALI** 34

SPECIAL PENCILS | LAPICES ESPECIALES | CRAYONS SPÉCIAUX | SPEZIALBLEISTIFTE

CUTTER 37

CUTTERS | CUTTERS | COUTEAUX | MESSER

PORTACHIAVI 42

KEYHOLDERS | LLAVEROS | PORTE-CLES | SCHLÜSSELANHÄNGER

LENTI D'INGRANDIMENTO 43

LENS | LUPAS | LOUPES | LUPEN

ROTELLE 47

LONG TAPE RULES | CINTAS | MESURES LONGUES | RAHMEN-BANDMASSE

MATITE IN LEGNO 48

SPECIAL PENCILS | LAPICES DE MADERA | CRAYONS EN BOIS | HOLZBLEISTIFTE

LIVELLE 50

LEVELS | NIVELES | NIVEAUX | WASSERWAAGEN

METRI PER SARTO - INCLINOMETRO 52TAYLOR'S TAPES | METROS PARA SASTRE | MÈTRES DE COUTURIER | SCHNEIDERMAßBÄNDER
INCLINOMETER | INCLINÓMETRO | INCLINOMÈTRE | NEIGUNGSWASSERWAAGE**CALIBRI BATTISTRADA** 54

TYRE GAUGES | MEDIDORES PNEUMATICOS | JAUGES PNEUS | REIFENPROFILMESSER

CALIBRI 55

CALIPERS | CALIBRES | PIEDS À COULISSE | MESSSCHIEBER

MISURATORI 57

GAUGES | MEDIDORES | JAUGES | MESSGERÄTE

RIGHE - RIGHELLI 59

RULES | REGLAS | RÈGLES | MAßSTÄBE - LINEALE

| | | | | |
|--------------|-----|-------|------------|------------------------|
| Ref. | L | | | |
| 98665 | 5 m | 25 mm | 56 x 54 mm | NR. COLOR 10 |

| | |
|------|---|
| Ref. | Codice prodotto Product code Código producto Code produit Produktcode |
|------|---|

| | | | | |
|--------------|-----|-------|------------|------------------------|
| Ref. | L | | | |
| 98665 | 5 m | 25 mm | 56 x 54 mm | NR. COLOR 10 |

| | | |
|-------|-----------|--|
| L | P | Informazioni tecniche del prodotto Technical information of the product Información técnica del producto Informations techniques du produit Technische Angaben des Produktes |
| L x H | H | |
| | C x P | |
| A | L x H x S | |

| | | | | |
|--------------|-----|-------|-------------------|------------------------|
| Ref. | L | | | |
| 98665 | 5 m | 25 mm | 56 x 54 mm | NR. COLOR 10 |

| | | |
|--|--|--|
| | | Dimensioni stampa Printing size Tamaño de impresión Dimensions de l'impression Druckgrößen |
| | | |
| | | |
| | | |
| | | |

| | | | | |
|--------------|-----|-------|------------|------------------------|
| Ref. | L | | | |
| 98665 | 5 m | 25 mm | 56 x 54 mm | NR. COLOR 10 |

| | | |
|---|---|---|
| | | |
| Stampa su etichetta Printing on sticker Impresión sobre etiqueta Impression sur étiquette Etikettendruck | Stampa con cliché Printing with cliché Impresión con cliché Impression avec cliché Druck mit Klischee | Stampa laser Laser printing Impresión láser Impression laser Laserdruck |
| | NR. COLOR | |
| Stampa diretta Direct printing Impression directe Impresión directa Direcktdruck | 1 2 3 10 | Numero di colori realizzabili Number of colors achievable Número de colores alcanzables Nombre de couleurs réalisables Anzahl der realisierbaren Farben |
| <p><i>Nel caso di stampa diretta con colore a pantone, possibile maggiorazione costo stampa calcolato in fase di preventivo.</i> <i>In case of printing directly with Pantone color, the printing costs can increase.</i> <i>En cas d'impression directement avec la couleur Pantone, les coûts d'impression peuvent augmenter.</i> <i>Im Fall des Direktdruckes mit Pantone-Farbe, können die Druckkosten höher aus fallen.</i> <i>En el caso de la impresión directa con el color Pantone, los costos de impresión pueden aumentar.</i></p> | | |

Flessometro con graduazione a lettura facilitata

Tape rule with graduation for easy reading

Flexómetro con graduación a lectura simplificada

Mètre à ruban avec graduation pour lecture facilitée

Rollbandmaß mit Teilung für vereinfachtes Ablesen



STAMPA SU ETICHETTA
PRINTING ON STICKER
IMPRESIÓN SOBRE ETIQUETA
IMPRESSION SUR ÉTIQUETTE
ETIKETTDRUCK

DOUBLE GRADUATION

DOUBLE GRADUATION

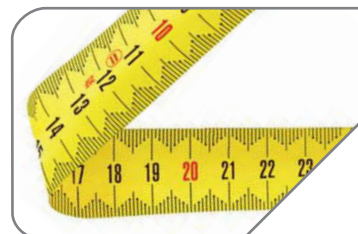

| Ref. | L | | | |
|-------|-----|-------|------------|-----------------|
| 98665 | 5 m | 25 mm | 56 x 54 mm | NR. COLOR 10 |

EASY READING

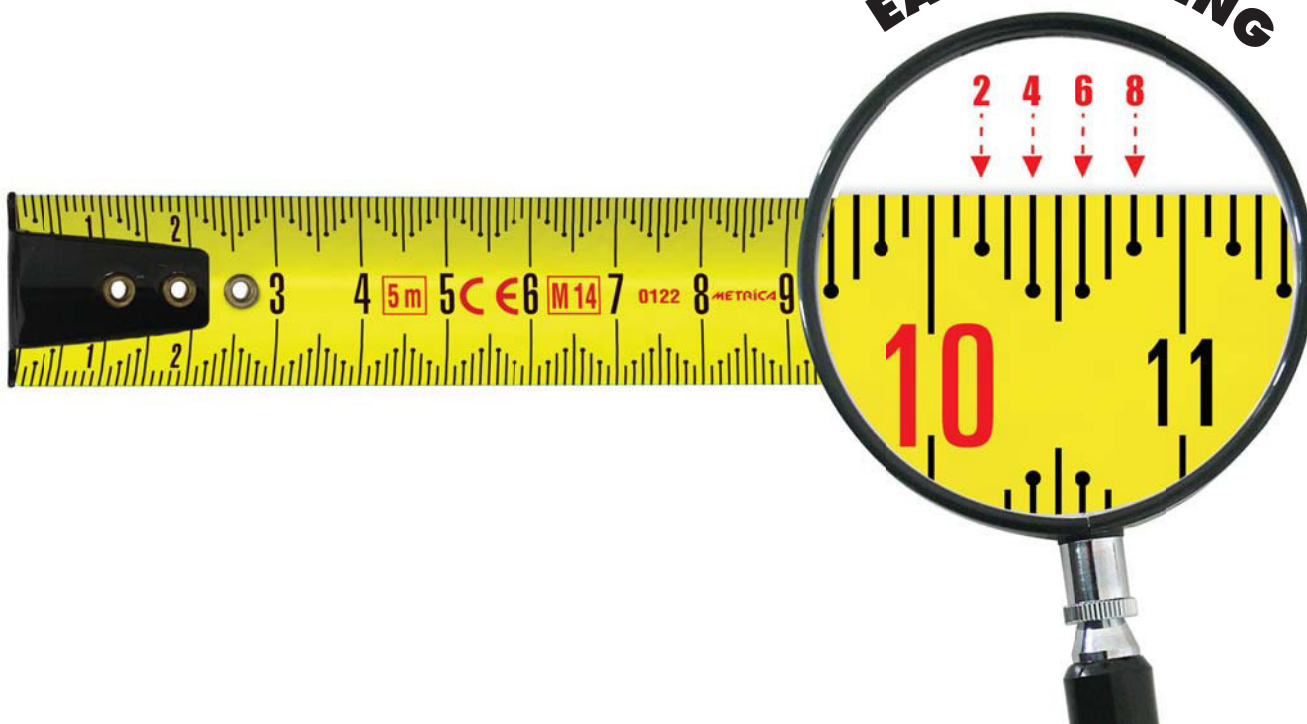

FLUORESCENT

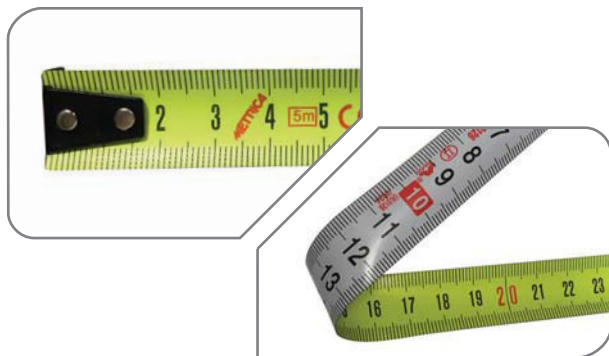

DOUBLE GRADUATION

Nastro fluorescente - doppia graduazione
cassa bimatériale

Fluorescent tape - double graduation
bi material case

Caja en bi-material
gancho revestido en caucho antideslizante

Boîtier en bimatériel
crochet revêtu en caoutchouc antiglissement



Kapsel aus Bi-Material
Spezial-Haken mit Gummiüberzug



STAMPA SU ETICHETTA
PRINTING ON STICKER
IMPRESIÓN SOBRE ETIQUETA
IMPRESSION SUR ÉTIQUETTE
ETIKETTDRUCK



METRICA FLASH

| Ref. | L |  |  |  |
|-------|-----|---|---|---|
| | | | | NR. COLOR |
| 98973 | 3 m | 16 mm | 38 x 38 mm | 10 |
| 98974 | 5 m | 19 mm | 44 x 44 mm | 10 |
| 98975 | 5 m | 25 mm | 44 x 44 mm | 10 |
| 98978 | 8 m | 25 mm | 52 x 52 mm | 10 |



STAMPA SU ETICHETTA
 PRINTING ON STICKER
 IMPRESIÓN SOBRE ETIQUETA
 IMPRESSION SUR ÉTIQUETTE
 ETIKETTDRUCK

Flessometro con superficie testurizzata del nastro - Alta protezione

Tape rule with textured surface of the top

Flexómetro con superficie texturada de la cinta

Mètre à ruban avec superficie texturé du ruban

Rollbandmaß mit texturierter Oberfläche des Bandes

| Ref. | L | | | |
|-------|-----|-------|---------|-----------------|
| 98765 | 5 m | 27 mm | Ø 45 mm | NR. COLOR 10 |
| 98768 | 8 m | 27 mm | Ø 50 mm | 10 |





STAMPA SU ETICHETTA
 PRINTING ON STICKER
 IMPRESIÓN SOBRE ETIQUETA
 IMPRESSION SUR ÉTIQUETTE
 ETIKETTDRUCK



NO SLIP



DOUBLE STOP

LIMITED EDITION

| Ref. | L | | | | NR. COLOR |
|-------|-----|-------|--------------|--|-----------|
| 98200 | 5 m | 19 mm | 42 x 37,5 mm | | 10 |
| 98202 | 8 m | 25 mm | 47 x 42,5 mm | | 10 |

Flessometro con magnete
 Doppio bloccaggio
 Speciale gancio con gomma antiscivolo
 Tape rule with magnet
 Double locking
 Esclusive hook with non-slip rubber
 Cinta con iman de enganche
 Double mecanismo de cierre
 Gancho revestido en caucho antideslizante
 Mètre à ruban avec crochet magnétique
 Double verrouillage
 Crochet revêtu en caoutchouc antiglissement
 Bandmaß mit Kupplungsmagnet
 Zweifach Stoppsystem
 Spezial-Haken mit Anti-Rutsch-Gummi

**FIX
 MAGNET**



Non in vendita in Francia, Germania, Gran Bretagna e USA
 Not on sale in France, Germany, UK and USA
 No en venta en Francia, Alemania, UK y USA
 Pas en vente en France, Allemagne, UK et États-Unis
 Verkauf in Frankreich, Deutschland, Großbritannien und USA ausgeschlossen



STAMPA SU ETICHETTA
 PRINTING ON STICKER
 IMPRESIÓN SOBRE ETIQUETA
 IMPRESSION SUR ÉTIQUETTE
 ETIKETTDRUCK

FLEXION RESISTANCE



Nastro 33 mm speciale gancio con gomma antiscivolo

Tape 33 mm wide exclusive hook with non-slip rubber

Cinta de 33 mm de ancho gancho revestido en caucho antideslizante

Ruban large 33 mm crochet revêtu en caoutchouc antiglissement

Bandbreite 33 mm Spezial-Haken mit Anti-Rutsch-Gummi

| Ref. | L | | | |
|-----------|-----|-------|---------|----|
| NR. COLOR | | | | |
| 98755 | 5 m | 33 mm | Ø 45 mm | 10 |
| 98758 | 8 m | 33 mm | Ø 50 mm | 10 |

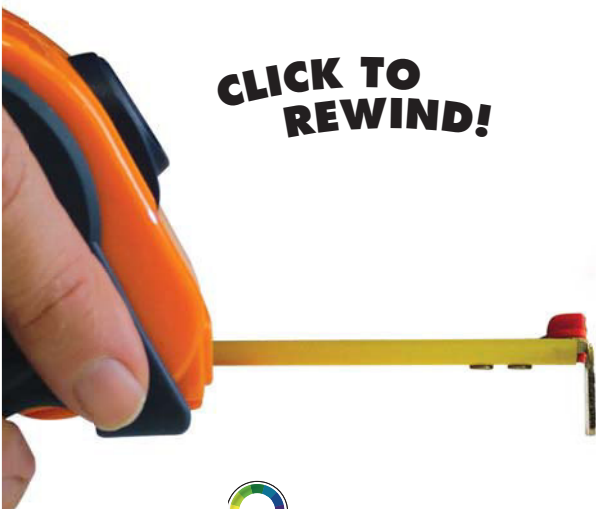

**CLICK TO
REWIND!**



STAMPA SU ETICHETTA
PRINTING ON STICKER
IMPRESIÓN SOBRE ETIQUETA
IMPRESSION SUR ÉTIQUETTE
ETIKETTD RUCK

Nastro autobloccante
Con magnete - Cassa gommata

Self locking tape
With magnet - Bi-material case

Cinta con autobloqueo
Con iman - Caja con caucho

Mètre à Ruban autobloquant
Avec aimant - Boîtier en bi-matériel

Selbstblockierendes Maßband
Mit Magnet - Gummierte Kapsel

**FIX
MAGNET**



**SELF
LOCKING**

| Ref. | L | | | |
|--------|-----|-------|------------|-----------------|
| 98415M | 5 m | 19 mm | 51 x 52 mm | NR. COLOR 10 |
| 98418M | 8 m | 25 mm | 58 x 59 mm | 10 |



TASTO REWIND

Nastro autobloccante
 Nastro bianco - Cassa gommata
 Self locking tape
 White tape - Bi-material case
 Cinta blanca con autobloqueo
 Caja gommada
 Mètre à ruban blanc autobloquant
 Boîtier en bi-matériau
 Selbstblockierendes weißes Band
 Gummierte Kapsel



STAMPA SU ETICHETTA
 PRINTING ON STICKER
 IMPRESIÓN SOBRE ETIQUETA
 IMPRESSION SUR ÉTIQUETTE
 ETIKETTDRUCK



**CLICK TO
 REWIND!**





SELF LOCKING

GIANT NUMBERS/NUMERI GIGANTI



OTHER MODELS/ALTRI MODELLI

| Ref. | L |  |  |  |
|-------|------|---|---|---|
| | | | | NR. COLOR |
| 98593 | 3 m | 16 mm | 31 x 43 mm | 10 |
| 98595 | 5 m | 19 mm | 40 x 48 mm | 10 |
| 98596 | 5 m | 25 mm | 40 x 48 mm | 10 |
| 98598 | 8 m | 25 mm | 47 x 56 mm | 10 |
| 98599 | 10 m | 25 mm | 47 x 57 mm | 10 |

Cassa bimateriale - 3 bottoni di bloccaggio
 Bimaterial case - 3 stop buttons
 Caja en bi-material - 3 botòns de bloqueo
 Caisse avec gaine en bimateriel
 3 boutons de blocage
 Kapsel aus Bi-Material - 3 Knöpfe



STAMPA SU ETICHETTA
 PRINTING ON STICKER
 IMPRESIÓN SOBRE ETIQUETA
 IMPRESSION SUR ÉTIQUETTE
 ETIKETTD RUCK

| Ref. | L | | | |
|-------|------|-------|------------|-----------|
| | | | | NR. COLOR |
| 98653 | 3 m | 16 mm | 32 x 34 mm | 10 |
| 98654 | 3 m | 19 mm | 32 x 34 mm | 10 |
| 98655 | 5 m | 19 mm | 40 x 42 mm | 10 |
| 98656 | 5 m | 25 mm | 40 x 42 mm | 10 |
| 98658 | 8 m | 25 mm | 46 x 44 mm | 10 |
| 98660 | 10 m | 25 mm | 52 x 50 mm | 10 |

Guaina in gomma
 Case with rubber
 Caja funda gomada
 Caisse avec gaine en caoutchouc
 Kapsel mit Gummiüberzug



| Ref. | L | | | |
|-------|-----|-------|------------|-----------|
| | | | | NR. COLOR |
| 98793 | 3 m | 16 mm | 38 x 38 mm | 10 |
| 98794 | 5 m | 19 mm | 46 x 41 mm | 10 |
| 98795 | 5 m | 25 mm | 46 x 41 mm | 10 |
| 98798 | 8 m | 25 mm | 50 x 45 mm | 10 |

| Ref. | L | | | |
|--------|-----|-------|---------|-----------|
| | | | | NR. COLOR |
| 98633L | 3 m | 16 mm | Ø 34 mm | 10 |
| 98635L | 5 m | 19 mm | Ø 39 mm | 10 |

Flessometro con magnete
 Tape rule with magnet
 Cinta con iman de enganche
 Mètre à Ruban avec crochet magnétique
 Rollbandmaß mit Magnet



| Ref. | L | | | |
|-------|-----|-------|------------|-----------------|
| 98597 | 5 m | 25 mm | 43 x 40 mm | NR. COLOR 10 |



STAMPA SU ETICHETTA
 PRINTING ON STICKER
 IMPRESIÓN SOBRE ETIQUETA
 IMPRESSION SUR ÉTIQUETTE
 ETIKETTDRUCK



Flessometro con graduazione su ambo i lati del nastro (orizzontale + verticale)

Graduation on both sides (horizontal + vertical)

Graduacion ambos lados (horizontal + vertical)

Graduation sur deux côtés (horizontal + vertical)

Teilung auf beiden Seiten (horizontal + vertikal)

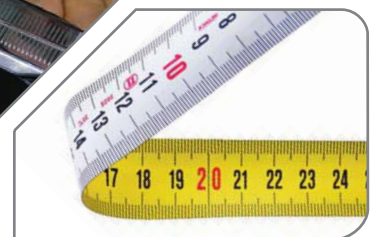

DOUBLE GRADUATION

| Ref. | L | | | |
|-------|-----|-------|------------|-----------------|
| 98605 | 5 m | 25 mm | 56 x 54 mm | NR. COLOR 10 |

Cassa cromata
 Chromed case
 Caja cromada
 Boîtier chromé
 Verchromte Kapsel



| Ref. | L | | | |
|--------------|-----|-------|---------|------------------------|
| 98192 | 2 m | 13 mm | Ø 41 mm | NR. COLOR 10 |
| 98193 | 3 m | 16 mm | Ø 41 mm | 10 |
| 98195 | 5 m | 19 mm | Ø 47 mm | 10 |
| 98196 | 5 m | 25 mm | Ø 47 mm | 10 |



STAMPA SU ETICHETTA
 PRINTING ON STICKER
 IMPRESIÓN SOBRE ETIQUETA
 IMPRESSION SUR ÉTIQUETTE
 ETIKETTD RUCK



| Ref. | L | | | |
|--------------|-----|-------|------------|------------------------|
| 98803 | 3 m | 16 mm | 37 x 35 mm | NR. COLOR 10 |
| 98804 | 5 m | 19 mm | 45 x 43 mm | 10 |
| 98805 | 5 m | 25 mm | 45 x 43 mm | 10 |

| Ref. | L | | | |
|--------------|-----|-------|------------|------------------------|
| 98432 | 2 m | 19 mm | 49 x 46 mm | NR. COLOR 10 |
| 98433 | 3 m | 19 mm | 49 x 47 mm | 10 |
| 98396 | 3 m | 25 mm | 56 x 54 mm | 10 |
| 98397 | 5 m | 25 mm | 56 x 54 mm | 10 |
| 98399 | 8 m | 25 mm | 64 x 64 mm | 10 |



| Ref. | L | | | |
|--------------|-----|-------|------------|------------------------|
| 98393 | 3 m | 13 mm | 29 x 46 mm | NR. COLOR 10 |



DOUBLE GRADUATION

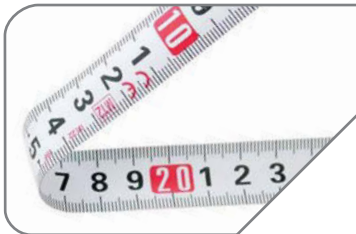

STAMPA SU ETICHETTA
PRINTING ON STICKER
IMPRESIÓN SOBRE ETIQUETA
IMPRESSION SUR ÉTIQUETTE
ETIKETTDRUCK

Nastro bianco con numerazione gigante, doppia graduazione (orizzontale e verticale) Cassa in ABS Gommata

White tape with giant numbers - Rubberized ABS case
Graduation on both sides (horizontal + vertical)

Cinta blanca con numeración gigante - Caja de ABS gomada
Graduación ambos lados (horizontal + vertical)

Ruban blanc et graduation à numération géante - Boîtier en ABS
Caoutchouté - Graduation sur deux côtés (horizontal + vertical)

Weißes Band und Teilung mit großen Zahlen - Gummierte
ABS-Kapsel - Teilung auf beiden Seiten (horizontal + vertikal)

| Ref. | L | | | |
|--------------|------|-------|------------|------------------------|
| 98320 | 3 m | 16 mm | 37 x 29 mm | NR. COLOR 10 |
| 98321 | 5 m | 19 mm | 41 x 32 mm | 10 |
| 98322 | 5 m | 25 mm | 42 x 34 mm | 10 |
| 98323 | 8 m | 25 mm | 47 x 37 mm | 10 |
| 98324 | 10 m | 25 mm | 57 x 42 mm | 10 |



1 bottone di bloccaggio + 2 freni

1 stop button + 2 brakes

1 botòns de bloqueo + 2 frenes

1 bouton de blocage + 2 freins

1 Blockierknopf + 2 Bremsen



| Ref. | L | | | |
|---------------|-----|-------|------------|------------------------|
| 98643H | 3 m | 16 mm | 36 x 24 mm | NR. COLOR 10 |
| 98645H | 5 m | 19 mm | 40 x 28 mm | 10 |
| 98646H | 5 m | 25 mm | 40 x 28 mm | 10 |
| 98647H | 6 m | 25 mm | 40 x 28 mm | 10 |
| 98648H | 8 m | 25 mm | 47 x 35 mm | 10 |

Nastro bianco, colori assortiti, doppia graduazione (orizzontale + verticale) - Cassa Trasparente

White tape, mixed colours, double graduation (horizontal + vertical) - Transparent case.

Cinta blanca, colores mixtos, graduación doble (horizontal + vertical) - Caja transparente

Ruban blanc, couleurs panachées, double graduation (horizontale + verticale) - Boîtier transparent

Weißes Band, gemischte Farben, doppelte Teilung (waagrecht + senkrecht) - Durchsichtige Kapsel



STAMPA SU ETICHETTA TRASPARENTE
DIGITAL PRINTING
IMPRESIÓN DIGITAL
IMPRESSION DIGITALE
DIGITALDRUCK

| Ref. | L | | | | | |
|-------|-------|-------|------------|-----------|-----------|-----------|
| | | | | NR. COLOR | NR. COLOR | NR. COLOR |
| 98751 | ● 3 m | 16 mm | 38 x 28 mm | 10 | 10 | 1 |
| 98761 | ● 3 m | 16 mm | 38 x 28 mm | 10 | 10 | 1 |
| 98771 | ● 3 m | 16 mm | 38 x 28 mm | 10 | 10 | 1 |
| 98754 | ● 5 m | 19 mm | 44 x 33 mm | 10 | 10 | 1 |
| 98764 | ● 5 m | 19 mm | 44 x 33 mm | 10 | 10 | 1 |
| 98774 | ● 5 m | 19 mm | 44 x 33 mm | 10 | 10 | 1 |



STAMPA DIRETTA
DIRECT PRINTING
IMPRESIÓN DIRECTA
IMPRESSION DIRECTE
DIREKTDRUCK



STAMPA SU ETICHETTA
PRINTING ON STICKER
IMPRESIÓN SOBRE ETIQUETA
IMPRESSION SUR ÉTIQUETTE
ETIKETTDRUCK

**OTHER COLORS ON REQUEST
ALTRI COLORI A RICHIESTA**

GIANT NUMBERS/NUMERI GIGANTI

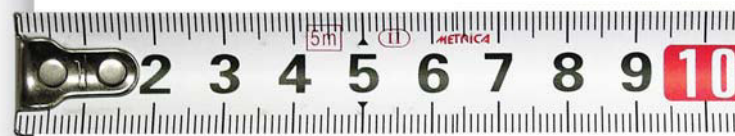

OTHER MODELS/ALTRI MODELLI

DOUBLE GRADUATION

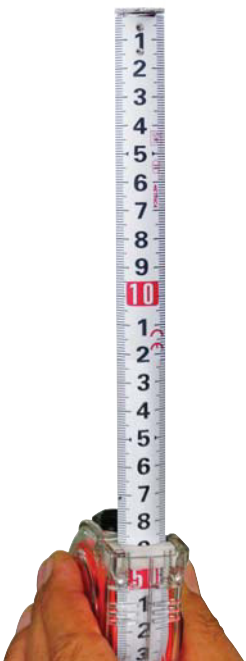
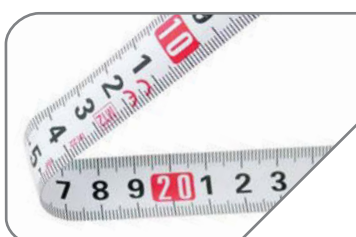

Cassa in ABS gialla
 Yellow ABS case
 Caja de ABS amarillo
 Boîtier en ABS jaune
 Gelbe ABS Kapsel



STAMPA SU ETICHETTA
 PRINTING ON STICKER
 IMPRESIÓN SOBRE ETIQUETA
 IMPRESSION SUR ÉTIQUETTE
 ETIKETTD RUCK



| Ref. | L | | | |
|-------|-----|-------|---------|-----------|
| | | | | NR. COLOR |
| 98362 | 2 m | 13 mm | Ø 40 mm | 10 |
| 98363 | 3 m | 16 mm | Ø 40 mm | 10 |
| 98365 | 5 m | 19 mm | Ø 45 mm | 10 |
| 98496 | 5 m | 25 mm | Ø 45 mm | 10 |

Cassa in ABS nera
 Black ABS case
 Caja de ABS negro
 Boîtier en ABS noir
 Schwarze ABS Kapsel



| Ref. | L | | | |
|-------|-----|-------|---------|-----------|
| | | | | NR. COLOR |
| 98172 | 2 m | 13 mm | Ø 42 mm | 10 |
| 98173 | 3 m | 16 mm | Ø 42 mm | 10 |
| 98175 | 5 m | 19 mm | Ø 47 mm | 10 |



STAMPA DIRETTA
 DIRECT PRINTING
 IMPRESIÓN DIRECTA
 IMPRESSION DIRECTE
 DIREKTDRUCK



Finestra di misura per interni
 Window for inside measure reading
 Lectura para medidas interiores
 Fenêtre pour lecture mesures intérieures
 Sichtfenster für Innenmessungen

















| Ref. | L | | | |
|-------|-----|-------|------------|-----------|
| | | | | NR. COLOR |
| 98263 | 3 m | 16 mm | 42 x 40 mm | 2 |

Cassa in ABS colori assortiti
 Red, green, yellow, black ABS case
 Caja de ABS roja, verde, amarilla, negra
 Bôitier en ABS rouge, vert, jaune, noir
 Rote, grüne, gelbe, schwarze ABS-Kapsel



STAMPA DIRETTA
 DIRECT PRINTING
 IMPRÉSION DIRECTA
 IMPRESSION DIRECTE
 DIRECKTDRUCK

| Ref. | L |  |  |  | NR. COLOR |
|-------|-----|---|---|---|-----------|
| 98922 | 2 m | 13 mm | 45 x 45 mm |  | 2 |
| 98912 | 2 m | 13 mm | 45 x 45 mm |  | 2 |
| 98892 | 2 m | 13 mm | 45 x 45 mm |  | 2 |
| 98932 | 2 m | 13 mm | 45 x 45 mm |  | 2 |
| 98923 | 3 m | 13 mm | 45 x 45 mm |  | 2 |
| 98913 | 3 m | 13 mm | 45 x 45 mm |  | 2 |
| 98893 | 3 m | 13 mm | 45 x 45 mm |  | 2 |
| 98933 | 3 m | 13 mm | 45 x 45 mm |  | 2 |
| 98925 | 5 m | 19 mm | 50 x 50 mm |  | 2 |
| 98915 | 5 m | 19 mm | 50 x 50 mm |  | 2 |
| 98895 | 5 m | 19 mm | 50 x 50 mm |  | 2 |
| 98935 | 5 m | 19 mm | 50 x 50 mm |  | 2 |

Metri a stecca
compound di legno al 50%

Folding rules with 50%
woodfibre compound



Mètres de compound de 50%
fibra de madera

Mètres pliants au compound à
50% fibre de bois

Gliedermaßstäbe aus 50%
Holzfasercompound

The Woody Rules



| Ref. | L |  |  |
|--------|-------|---|---|
| | | | NR. COLOR |
| 18001N | ● 2 m | 27 x 160 mm | 2 |
| 19001N | ● 1 m | 18 x 90 mm | 2 |





STAMPA DIRETTA
DIRECT PRINTING
IMPRESION DIRECTA
IMPRESSION DIRECTE
DIREKTDRUCK

Metri a stecca con bordi
ad effetto fluorescente
Folding rules
with fluorescent effect edges
Metros con bordes
de efectos fluorescente
Mètres pliants avec bords
à effet fluorescent
Gliedermaßstäbe
mit fluoreszierend - Effekt-Kanten

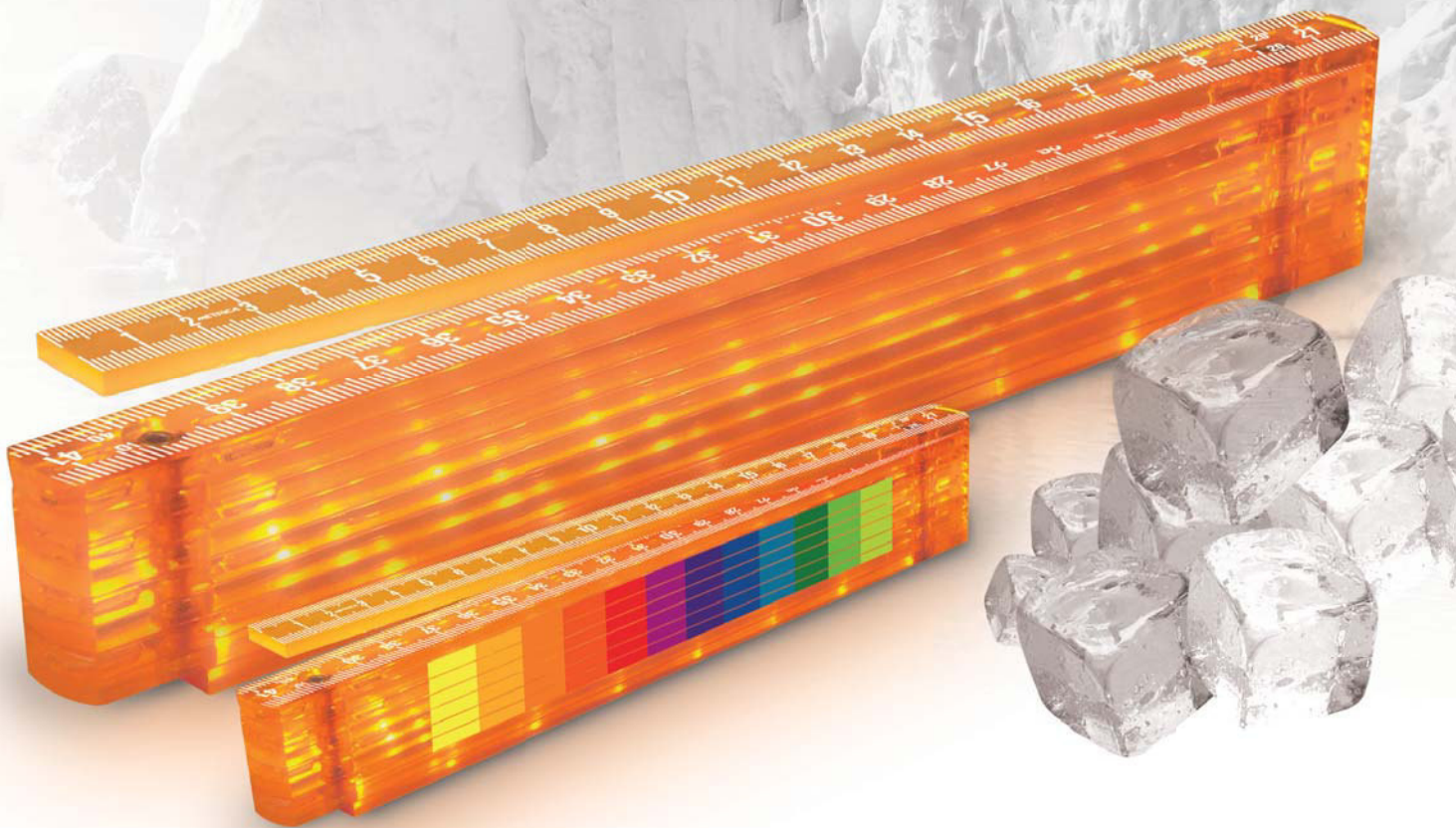
The Ice Effect



| Ref. | L |  |  |
|-------|----------|---|---|
| | | | NR. COLOR |
| 18026 | ● 1,99 m | 27 x 160 mm | 2 |
| 19026 | ● 0,99 m | 18 x 90 mm | 2 |

STAMPA DIRETTA
DIRECT PRINTING
IMPRESSION DIRECTA
IMPRESSION DIRECTE
DIRECKTDRUCK

3 metri 3 meters 3 metros 3 mètres 3 meter

- 3m Gigante
fibra di vetro
- 3m Big size type
Fiberglass
- 3m
Fibra de vidrio
- 3m Géant
Fibre de verre
- 3m
Glasfaser

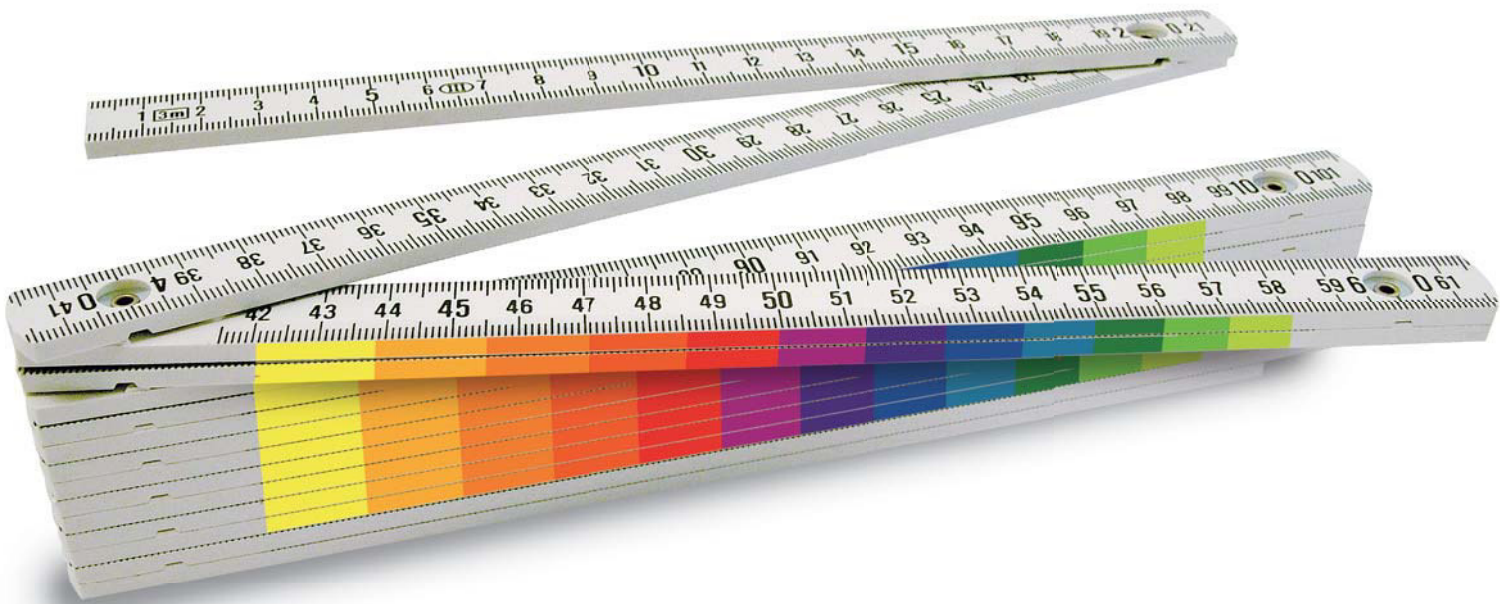

| Ref. | | L | | | | NR. COLOR | | | NR. COLOR |
|-------|---|-----|-------------|--|--|-----------|-------------|--|-----------|
| 18070 | ○ | 3 m | 40 x 160 mm | | | 3 | — | | — |
| 18080 | ● | 3 m | 40 x 160 mm | | | 3 | — | | — |
| 18071 | ○ | 3 m | 40 x 160 mm | | | 3 | 10 x 160 mm | | 1 |
| 18081 | ● | 3 m | 40 x 160 mm | | | 3 | 10 x 160 mm | | 1 |



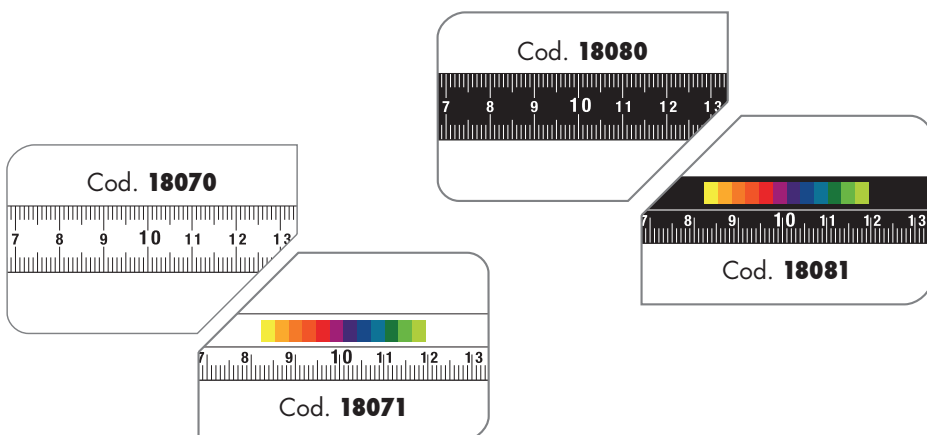

STAMPA DIRETTA
DIRECT PRINTING
IMPRESSION DIRECTA
IMPRESSION DIRECTE
DIRECKTDRUCK

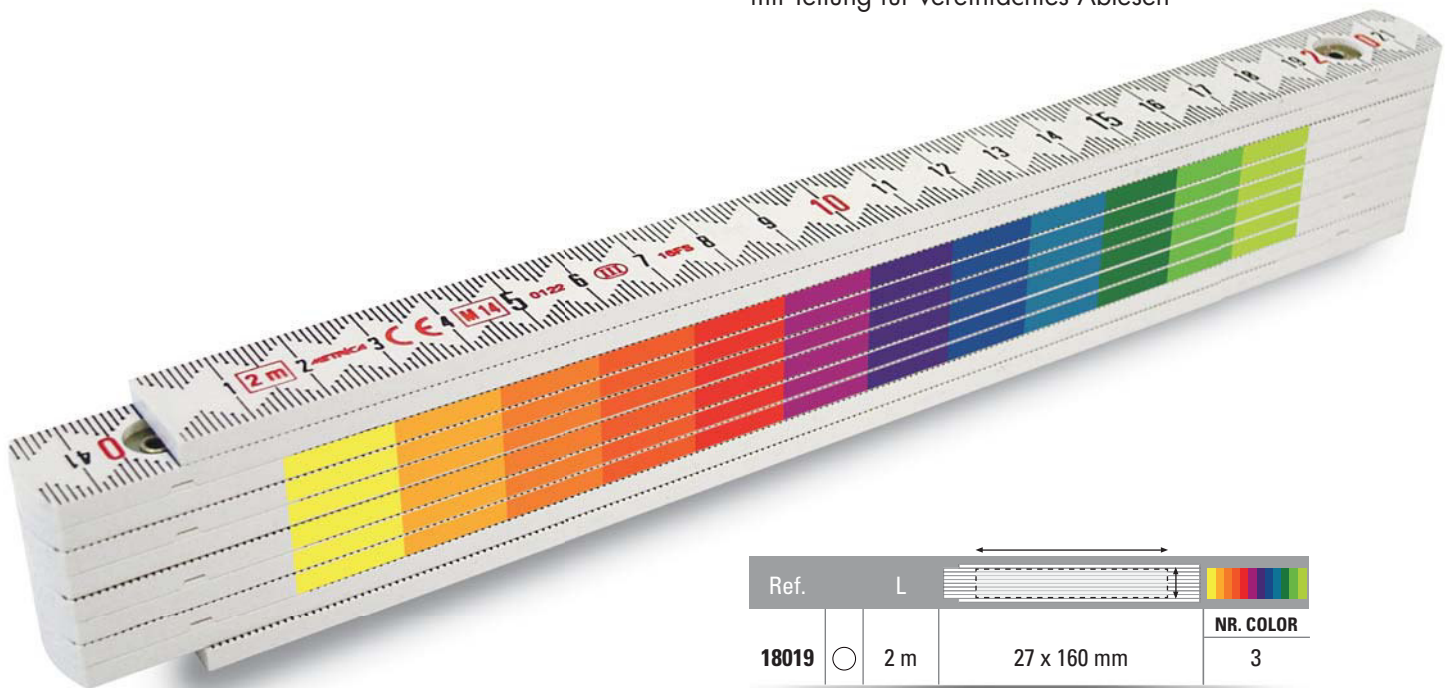

NEW GRADUATION

- 2 m fibra di vetro
con graduazione a lettura facilitata
- 2 m folding rule fibreglas
with graduation for easing reading
- 2 m fibra de vidrio
con graduación a lectura simplificada
- 2 m fibre de verre
avec graduation pour lecture facilitée
- 2 m Gliedermaßstab
mit Teilung für vereinfachtes Ablesen



| Ref. | L |  |  |
|-------|-------|---|---|
| 18019 | ○ 2 m | 27 x 160 mm | NR. COLOR 3 |

 STAMPA DIRETTA
 DIRECT PRINTING
 IMPRÉSION DIRECTA
 IMPRESSION DIRECTE
 DIRECKTDRUCK



2m Fibra di vetro
 2m Fiberglass
 2m Fibra de vidrio
 2m Fibre de verre
 2m Glasfaser

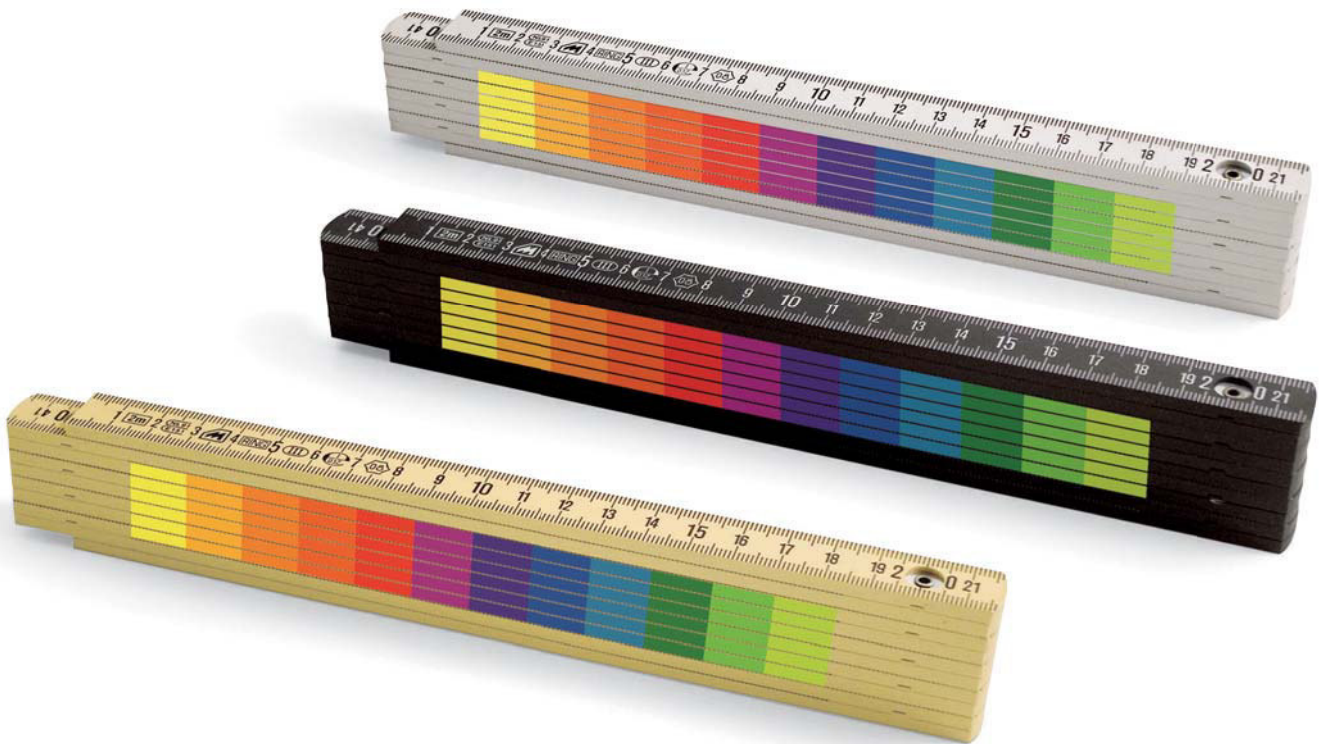

STAMPA DIRETTA
 DIRECT PRINTING
 IMPRESSION DIRECTA
 IMPRESSION DIRECTE
 DIRECKTDRUCK

| Ref. | L | Diagram | Diagram | Color calibration | |
|-------|-------|-------------|---------|-------------------|-----------|
| | | | | NR. COLOR | NR. COLOR |
| 18010 | ○ 2 m | 27 x 160 mm | 3 | — | — |
| 18020 | ○ 2 m | 27 x 160 mm | 3 | — | — |
| 18030 | ● 2 m | 27 x 160 mm | 3 | — | — |
| 18011 | ○ 2 m | 27 x 160 mm | 3 | 6 x 160 mm | 1 |
| 18021 | ○ 2 m | 27 x 160 mm | 3 | 6 x 160 mm | 1 |
| 18031 | ● 2 m | 27 x 160 mm | 3 | 6 x 160 mm | 1 |

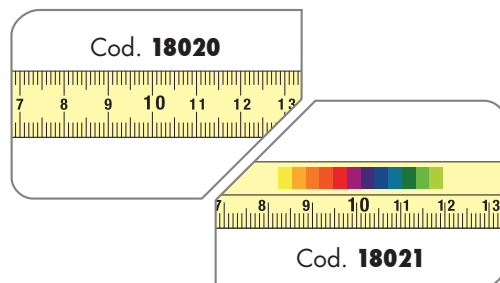
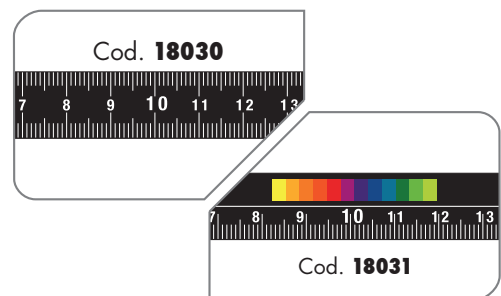
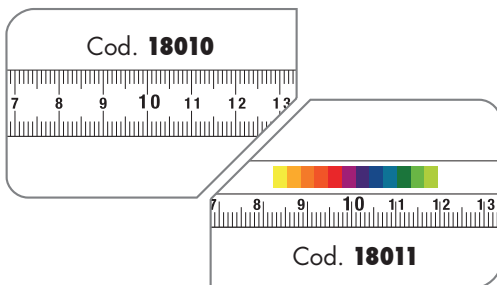

- 2m Fibra di vetro. Decimali rossi
- 2m Fiberglass. Red decimals
- 2m Fibra de vidrio. Decimal en rojo
- 2m Fibre de verre. Décimales en rouge
- 2m Glasfaser. Rote Dezimalen

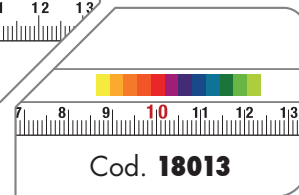
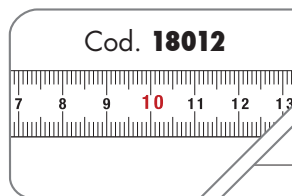

STAMPA DIRETTA
DIRECT PRINTING
IMPRESSION DIRECTA
IMPRESSION DIRECTE
DIRECKTDRUCK

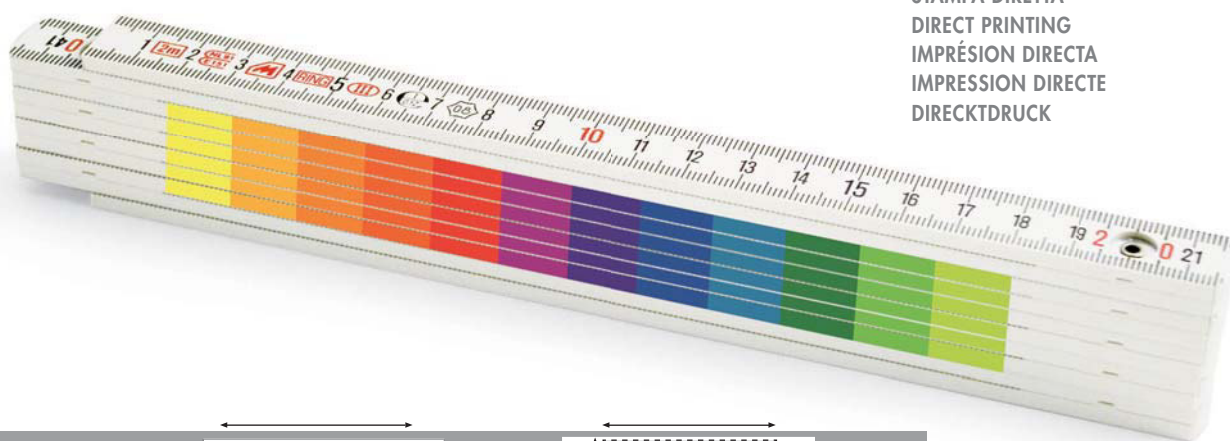

| Ref. | L | | | NR. COLOR | | NR. COLOR |
|-------|-----|-------------|------------|-----------|---|-----------|
| 18012 | 2 m | 27 x 160 mm | | 3 | — | |
| 18013 | 2 m | 27 x 160 mm | 6 x 160 mm | 3 | | 1 |

- 2m Fibra di vetro con aste calamitate
- 2m Fiberglass with magnets
- 2m Fibra de vidrio con imanes
- 2m Fibre de verre avec aimant
- 2m Glasfasergliedermaßstab mit Magnet

STAMPA DIRETTA
DIRECT PRINTING
IMPRESSION DIRECTA
IMPRESSION DIRECTE
DIRECKTDRUCK

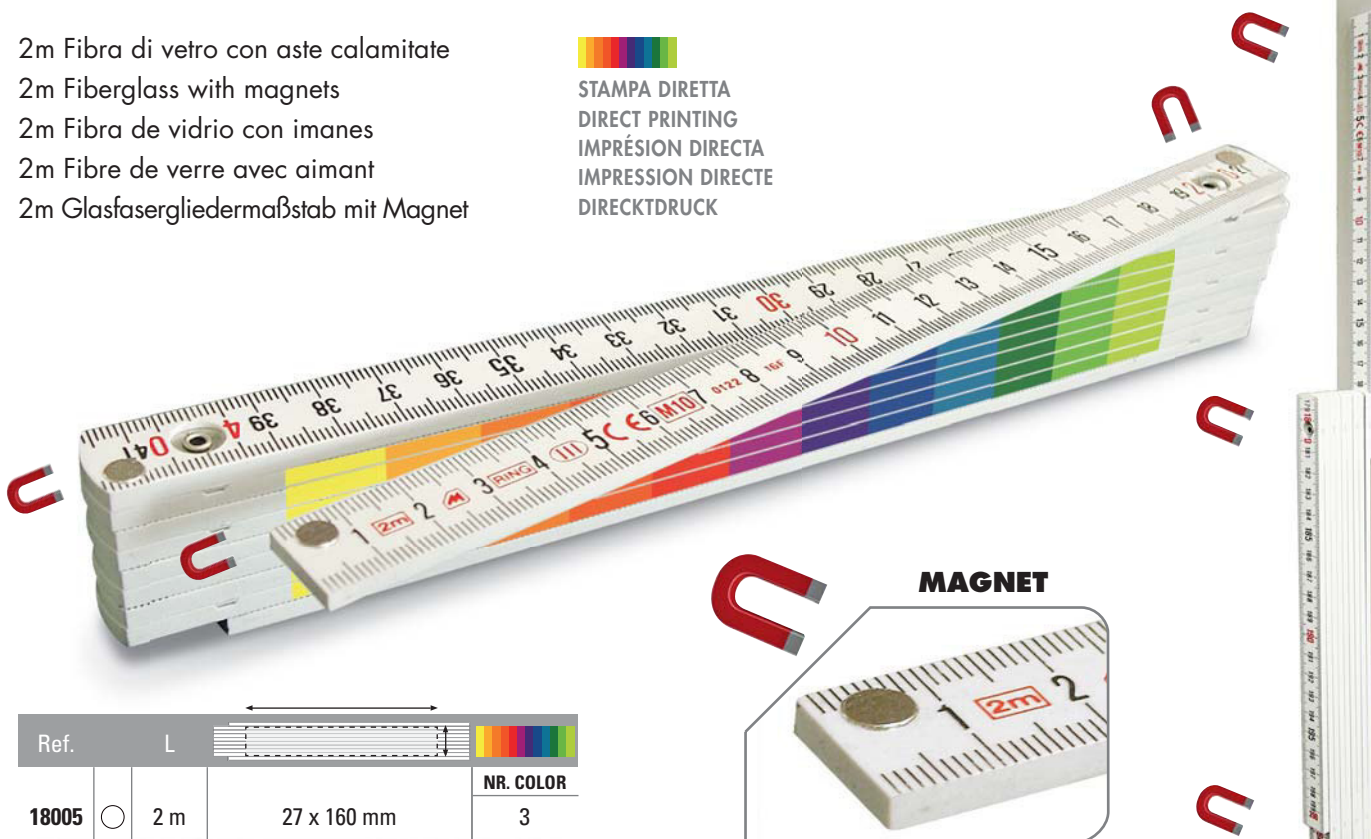

| Ref. | L | | NR. COLOR |
|-------|-----|-------------|-----------|
| 18005 | 2 m | 27 x 160 mm | 3 |

FLAT MEASURING

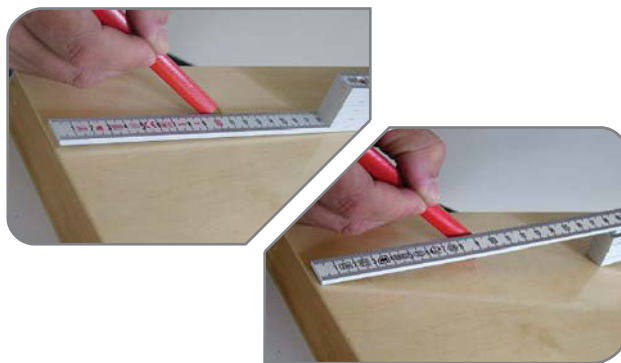

2m Fibra di vetro per falegnami
 2m folding rule fibreglas
 for carpenters
 2m de fibra para carpintero
 Mètre pliant 2m fibre
 pour charpentiers
 Gliedermassstab 2m
 Glasfaser für Schreiner

OTHER MODELS/ALTRI MODELLI

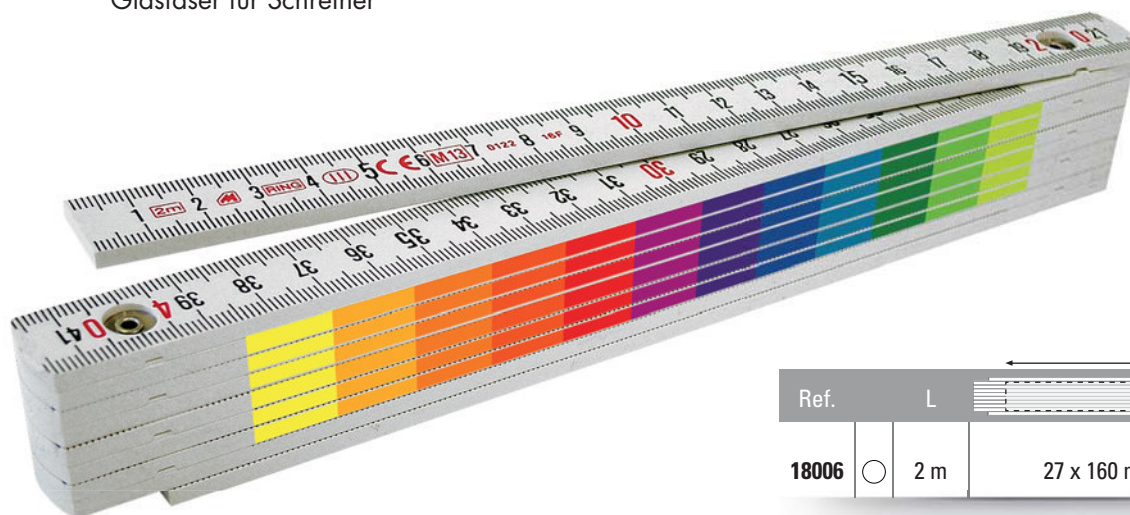

STAMPA DIRETTA
 DIRECT PRINTING
 IMPRESSION DIRECTA
 IMPRESSION DIRECTE
 DIRECKTDRUCK

| Ref. | | L | | |
|-------|---|-----|-------------|----------------|
| 18006 | ○ | 2 m | 27 x 160 mm | NR. COLOR 3 |

2m Fibra di vetro con gancio
 2m Fiberglass with end hook
 2m Fibra de vidrio con gancho deslizante
 2m Fibre de verre avec crochet
 2m Glasfasergliedermaßstab mit Griffhaken

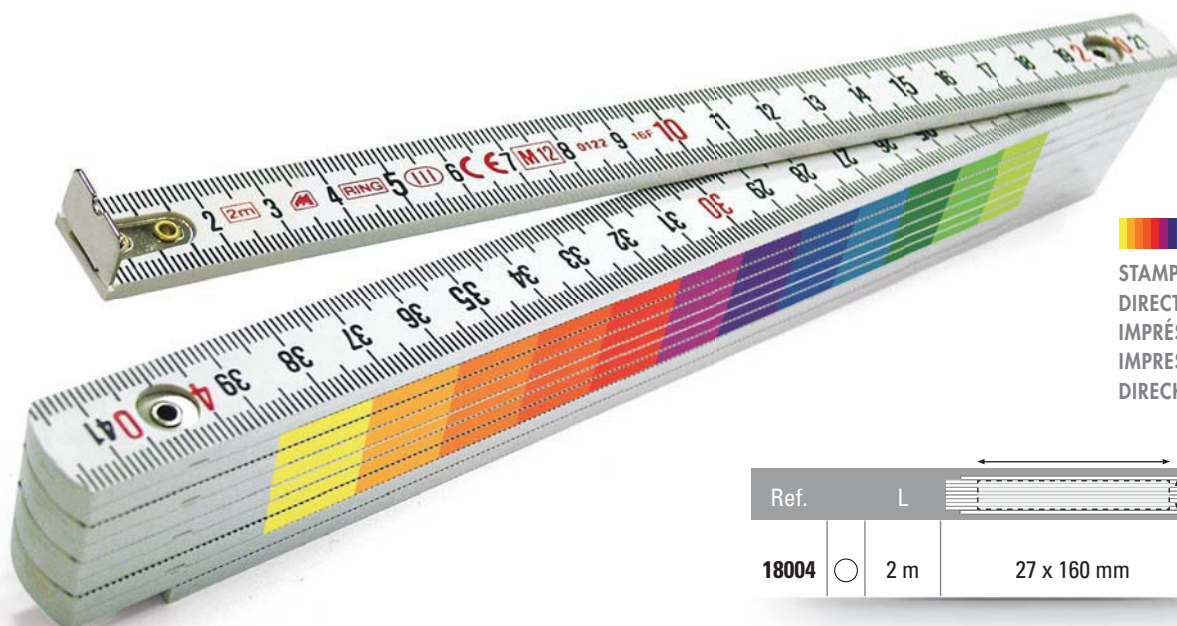
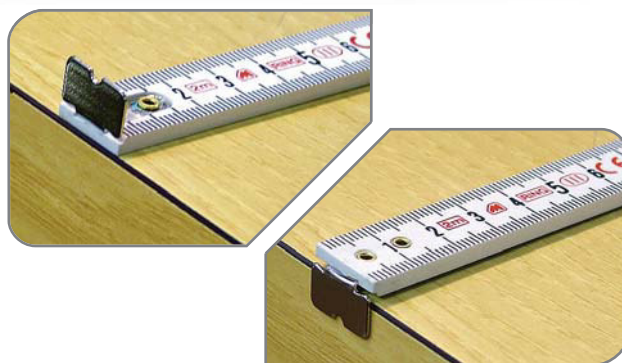

STAMPA DIRETTA
 DIRECT PRINTING
 IMPRESSION DIRECTA
 IMPRESSION DIRECTE
 DIRECKTDRUCK

| Ref. | | L | | |
|-------|---|-----|-------------|----------------|
| 18004 | ○ | 2 m | 27 x 160 mm | NR. COLOR 3 |



1m Fibra di vetro
 1m Fiberglass
 1m Fibra de vidrio
 1m Fibre de verre
 1m Glasfaser

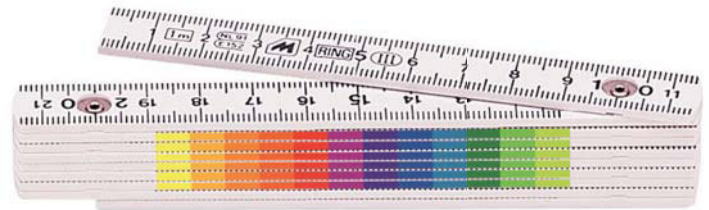

 STAMPA DIRETTA
 DIRECT PRINTING
 IMPRESSION DIRECTA
 IMPRESSION DIRECTE
 DIRECKTDRUCK

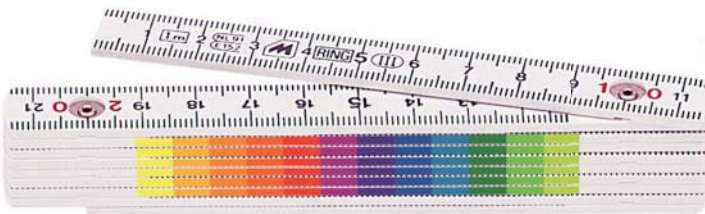

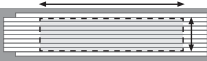
1m Fibra di vetro - Decimali rossi
 1m Fiberglass - Red decimals
 1m Fibra de vidrio - Decimal en rojo
 1m Fibre de verre - Décimales en rouge
 1m Glasfaser - Rote Dezimalen



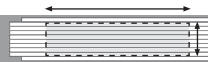

| Ref. | | L |  |  |
|-------|---|-----|---|---|
| | | | | NR. COLOR |
| 19040 | ○ | 1 m | 18 x 90 mm | 3 |
| 19050 | ● | 1 m | 18 x 90 mm | 3 |
| 19060 | ● | 1 m | 18 x 90 mm | 3 |

| Ref. | | L |  |  |
|-------|---|-----|---|---|
| | | | | NR. COLOR |
| 19043 | ○ | 1 m | 18 x 90 mm | 3 |

1m Fibra di vetro
 Astina estendibile
 per bocce
 1m Fiberglass
 extension rod
 1m Fibra de vidrio
 con asta
 1m Fibre de verre
 à tirette
 1m Glasfaser
 mit Stahlzunge

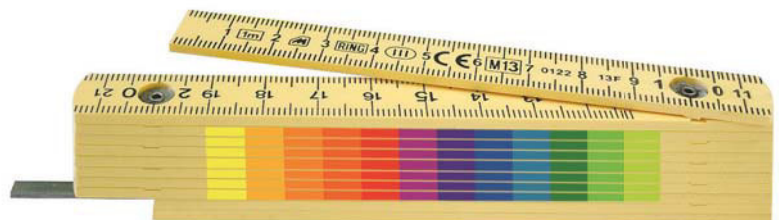
 STAMPA DIRETTA
 DIRECT PRINTING
 IMPRESSION DIRECTA
 IMPRESSION DIRECTE
 DIRECKTDRUCK

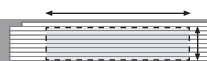

| Ref. | | L |  |  |
|-------|---|-----|---|---|
| | | | | NR. COLOR |
| 20136 | ● | 1 m | 18 x 90 mm | 3 |

3 metri 3 meters 3 metros 3 mètres 3 meter

3m Legno. Gigante
Perni invisibili. Decimali rossi

3m Wooden. Big size type
Hidden rivets. Red decimals



3m Madera.
Rivetes invisibles. Decimal en rojo

3m Bois. Géant
Rivets invisibles. Décimales en rouge

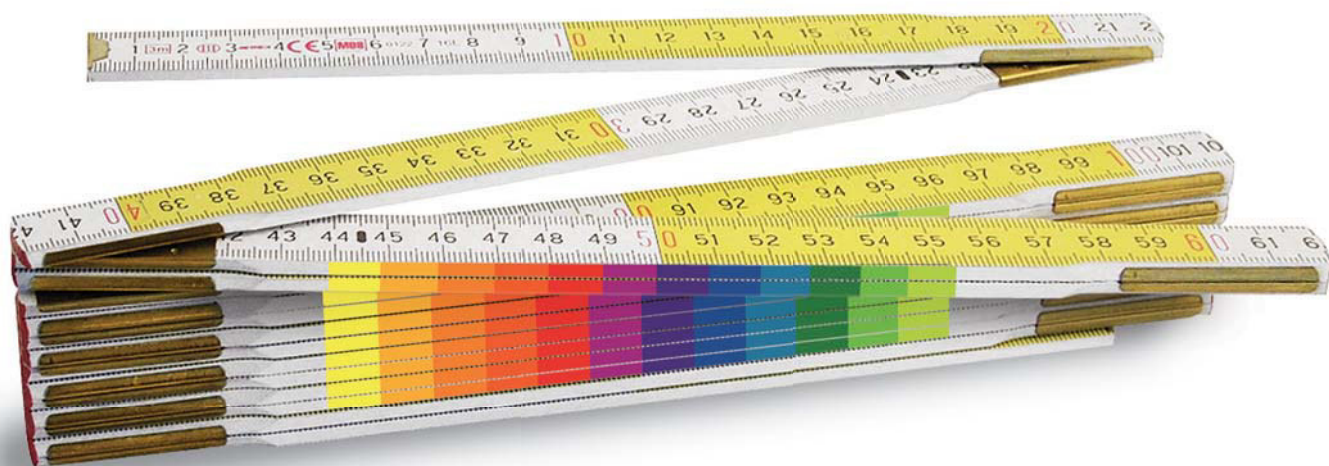
3m Holz
Verdeckte Nieten. Rote Dezimalen



STAMPA DIRETTA
DIRECT PRINTING
IMPRESSION DIRECTA
IMPRESSION DIRECTE
DIRECKTDRUCK

| Ref. | L |  |  |
|-------|---|---|---|
| | | | NR. COLOR |
| 23169 |  3 m | 40 x 140 mm | 3 |

2m Legno. Professionale. Tipo bosso. Molle interne
 2m Wooden. Stiff model. Inside springs. Professional model
 2m Madera. Resorte incorporado. Modelo profesionales
 2m Bois. Modèle rigide. Ressorts incorporés. Model professionnel
 2m Holz. Innenfedern. Professionelles Modell

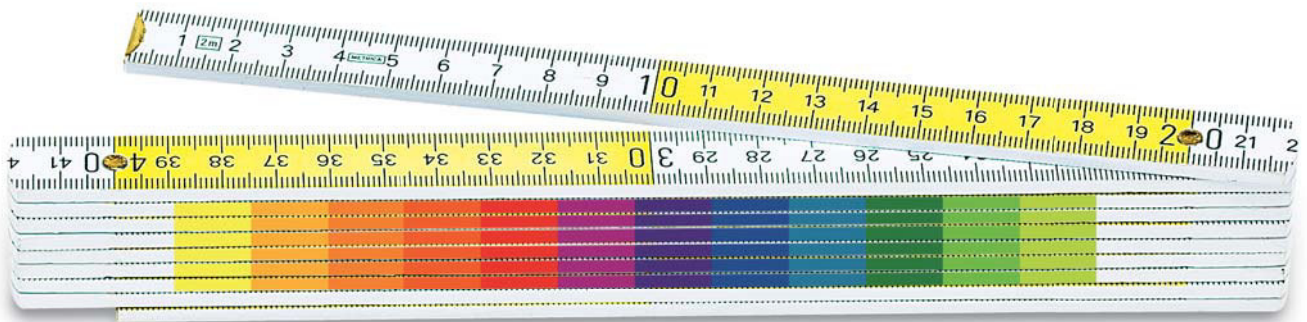

| Ref. | L | | | NR. COLOR | | | NR. COLOR |
|-------|-----|-------------|--|-----------|------------|--|-----------|
| 23080 | 2 m | 27 x 160 mm | | 3 | — | | — |
| 23081 | 2 m | 27 x 160 mm | | 3 | 6 x 160 mm | | 1 |

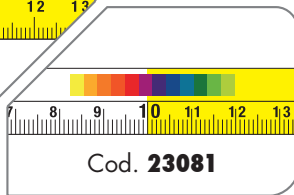
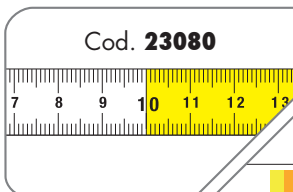

STAMPA DIRETTA
 DIRECT PRINTING
 IMPRESSION DIRECTA
 IMPRESSION DIRECTE
 DIRECKTDRUCK

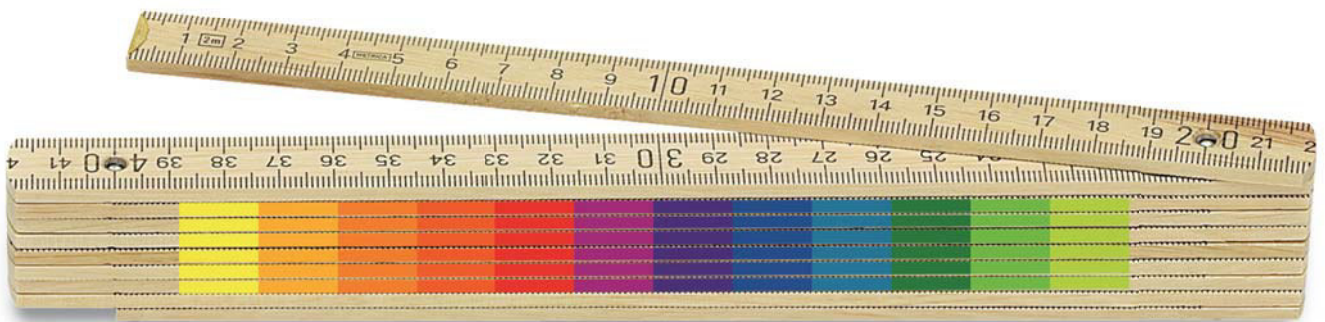

| Ref. | L | | | NR. COLOR | | | NR. COLOR |
|-------|-----|-------------|--|-----------|------------|--|-----------|
| 23090 | 2 m | 27 x 160 mm | | 3 | — | | — |
| 23091 | 2 m | 27 x 160 mm | | 3 | 6 x 160 mm | | 1 |
| 23093 | 2 m | 27 x 160 mm | | 3 | — | | — |

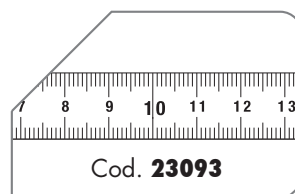
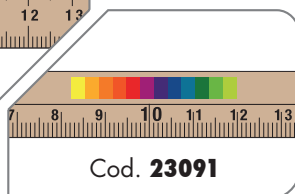
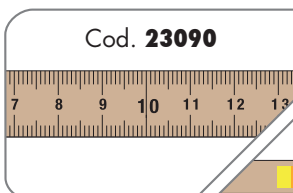

STAMPA DIRETTA
 DIRECT PRINTING
 IMPRESSION DIRECTA
 IMPRESSION DIRECTE
 DIRECKTDRUCK

2m betulla - Modello professionale - Decimali rossi
 Molto sottile - Super flessibile

2m birch - Professional model - Red decimal
 Very thin - Super flexible

2m abedul - Modelo profesional - Decimal rojo
 Muy delgada - Super flexible

2m bouleau - Modèle professionnel - Décimales rouges
 Très fin - Super flexible

2m Birke - Professionelle Ausführung - Rote Dezimalen
 Sehr dünn - Super flexibel

BETULLA
BIRCH
ABEDUL
BOULEAU
BIRKE

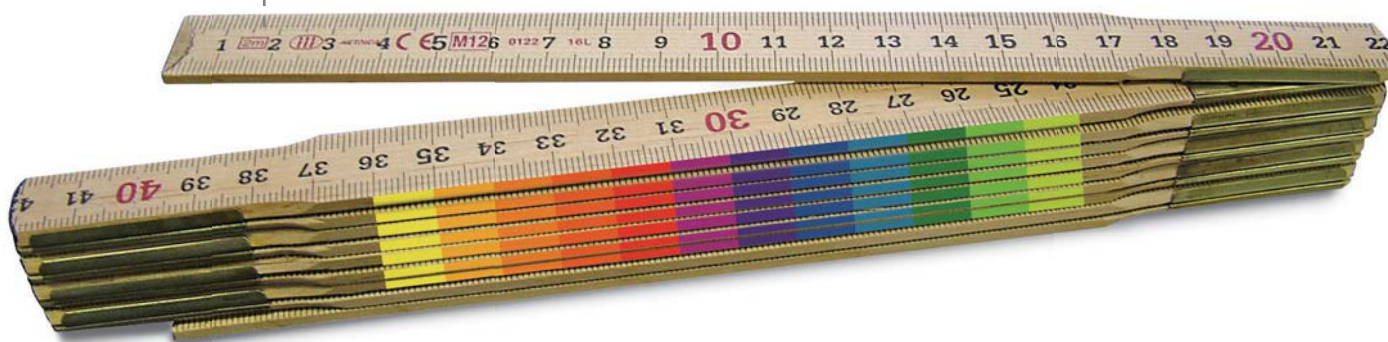

STAMPA DIRETTA
 DIRECT PRINTING
 IMPRESSION DIRECTA
 IMPRESSION DIRECTE
 DIRECKTDRUCK

| Ref. | L | | |
|-------|-----|-------------|----------------|
| 23300 | 2 m | 21 x 140 mm | NR. COLOR 3 |

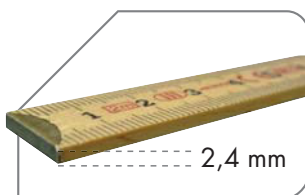

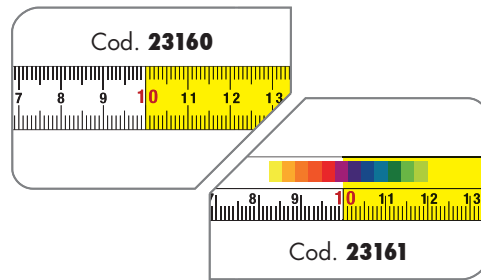

2m Legno - professionale
Decimali rossi

2m Wooden - Professional model
Red decimals

2m Madera - Modelo profesionales
Decimal en rojo

2m Bois - Model professionnel
Décimales en rouge

2m Holz Riesen-Set
Rote Dezimalen - professionelles Modell

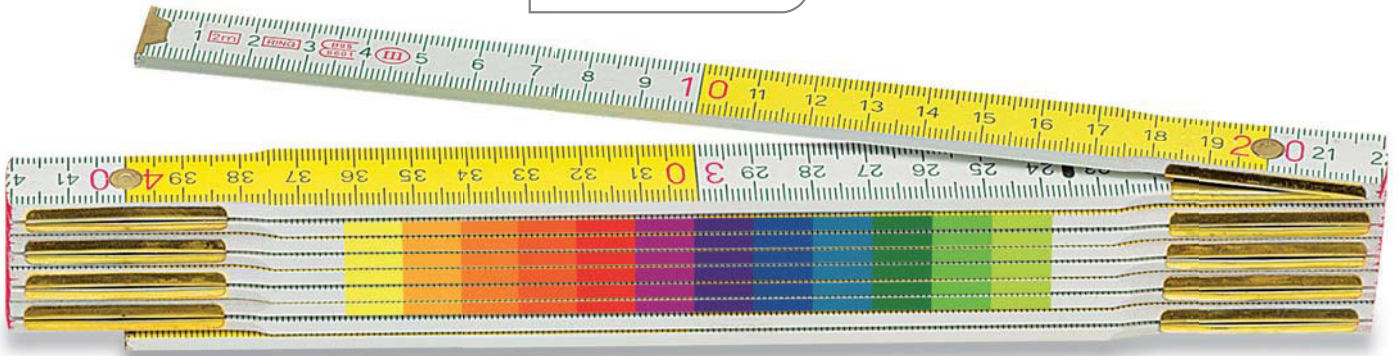

STAMPA DIRETTA
DIRECT PRINTING
IMPRÉSION DIRECTA
IMPRESSION DIRECTE
DIRECKTDRUCK

| Ref. | L | Diagram | Diagram | | |
|-------|-----|---------|-----------|------------|-----------|
| | | | NR. COLOR | Diagram | NR. COLOR |
| 23160 | 2 m | | 3 | — | |
| 23161 | 2 m | | 3 | 6 x 160 mm | 1 |



STAMPA DIRETTA
DIRECT PRINTING
IMPRÉSION DIRECTA
IMPRESSION DIRECTE
DIRECKTDRUCK

2m Legno - professionale
Decimali rossi

2m Wooden - Professional model
Red decimals

2m Madera - Modelo profesionales
Decimal en rojo

2m Bois - Model professionnel
Décimales en rouge

2m Holz Riesen-Set
Rote Dezimalen - professionelles Modell

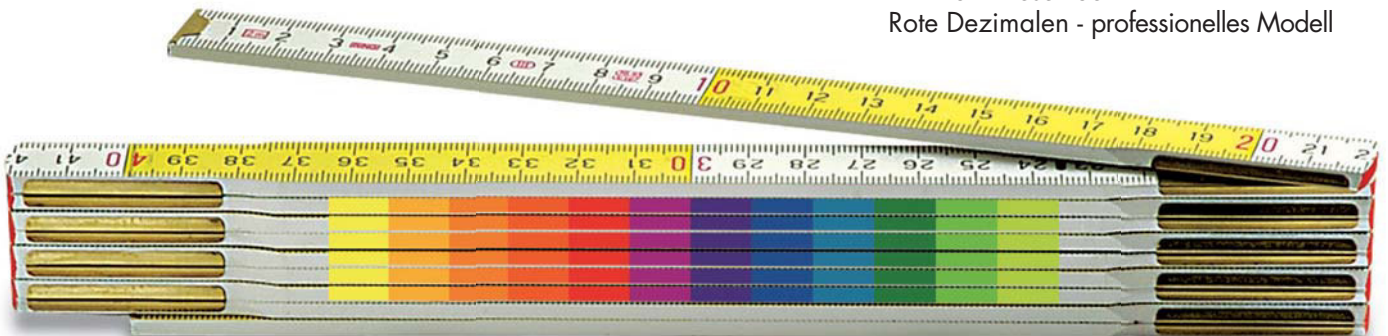

| Ref. | L | Diagram | Diagram | |
|-------|-----|---------|-----------|---------|
| | | | NR. COLOR | Diagram |
| 23162 | 2 m | | 3 | |

2m Legno - Semigigante
 professionale - Decimali rossi

2m Wooden - Profesional model
 Red decimals

2m Madera - Modelo profesionales
 Decimal en rojo

2m Bois - Model professionelle
 Décimales en rouge

2m Holz - Rote Dezimalen
 professionelles Modell



| Ref. | L | | | NR. COLOR | | NR. COLOR |
|-------|-----|-------------|--|-----------|------------|-----------|
| 23130 | 2 m | 27 x 140 mm | | 3 | — | — |
| 23150 | 2 m | 27 x 140 mm | | 3 | — | — |
| 23140 | 2 m | 27 x 140 mm | | 3 | — | — |
| 23131 | 2 m | 27 x 140 mm | | 3 | 6 x 160 mm | 1 |
| 23151 | 2 m | 27 x 140 mm | | 3 | 6 x 160 mm | 1 |
| 23141 | 2 m | 27 x 140 mm | | 3 | 6 x 160 mm | 1 |



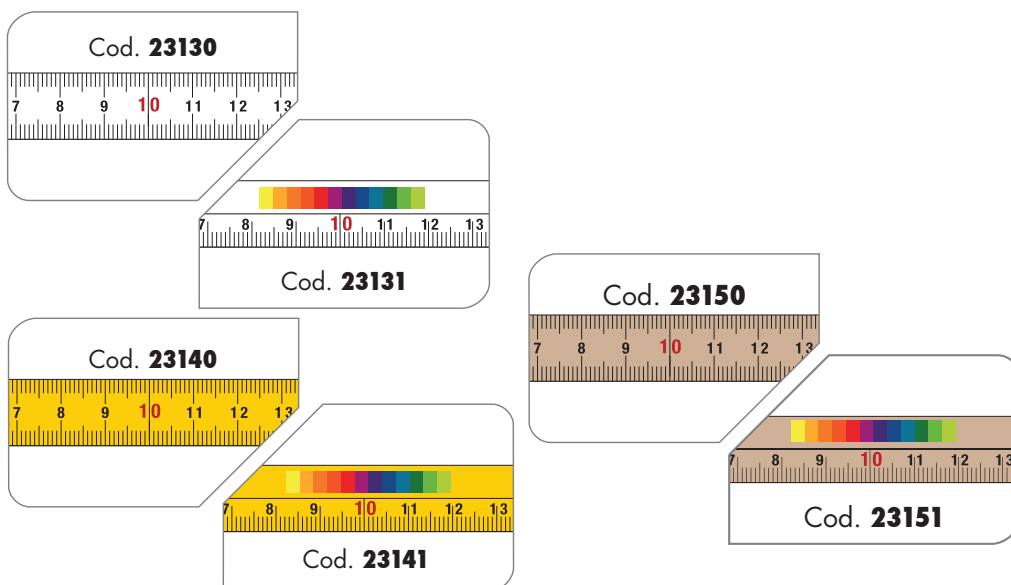

STAMPA DIRETTA
 DIRECT PRINTING
 IMPRESSION DIRECTA
 IMPRESSION DIRECTE
 DIRECKTDRUCK



2m legno - Modello professionale
 2m Wooden - Profesional model
 2m Madera - Modelo profesional
 2m Bois - Modèle professionnel
 2m Holz - Professionelles Modell



 STAMPA DIRETTA
 DIRECT PRINTING
 IMPRESSION DIRECTA
 IMPRESSION DIRECTE
 DIRECKTDRUCK

| Ref. | L |  |  |
|---------------|-------|---|---|
| | | | NR. COLOR |
| 23128 | ○ 2 m | 6 x 160 mm | 3 |
| 23126 | ● 2 m | 6 x 160 mm | 3 |
| 23085H | ● 2 m | 6 x 160 mm | 3 |
| 23085 | ● 2 m | 6 x 160 mm | 3 |

Ref. 23085H - 23085

Chiodo coperto
 Hidden rivets
 Pernos invisibles
 Ressorts incorporés
 Verdeckte Nieten

Ref. 23128



Ref. 23126



Ref. 23085H



Ref. 23085



2m Legno - Decimali rossi
 2m Wooden - Red decimals
 2m Madera - Decimal en rojo
 2m Bois - Décimales en rouge
 2m Holz - Rote Dezimalen



STAMPA DIRETTA
 SULLA PRIMA STECCA
 DIRECT PRINTING
 ON THE FIRST FOLD
 IMPRESIÓN DIRECTA SOBRA
 LA PRIMERA VARILLA
 IMPRESSION DIRECTE
 SUR LA PREMIÈRE BRANCHE
 DIREKTDRUCK
 AUF DEM ERSTEN GLIED



| Ref. | L | | NR. COLOR |
|-------|-----|------------|-----------|
| 23153 | 2 m | 6 x 160 mm | 1 |
| 23168 | 2 m | 6 x 160 mm | 1 |
| 23111 | 2 m | 6 x 160 mm | 1 |
| 23121 | 2 m | 6 x 160 mm | 1 |

2m Legno Semigigante
 Perni invisibili - Decimali rossi

2m Wooden Big size type
 Hidden rivets - Red decimals

2m Madera - Rivetes invisible
 Decimal en rojo

2m Bois - Sémi-géant
 Rivets invisible - Décimales en rouge

2m Holz - Verdeckte Nieten
 Rote Dezimalen

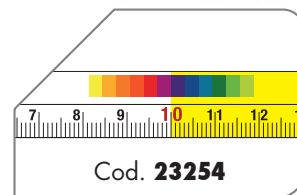
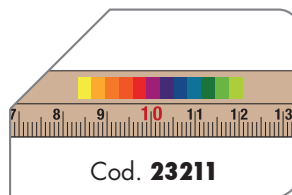

STAMPA DIRETTA
 DIRECT PRINTING
 IMPRESIÓN DIRECTA
 IMPRESSION DIRECTE
 DIREKTDRUCK

| Ref. | L | | NR. COLOR | NR. COLOR |
|-------|-----|-------------|-----------|-----------|
| 23254 | 2 m | 27 x 140 mm | 3 | 1 |
| 23211 | 2 m | 27 x 140 mm | 3 | 1 |



STAMPA SU ETICHETTA
 PRINTING ON STICKER
 IMPRESIÓN SOBRE ETIQUETA
 IMPRESSION SUR ÉTIQUETTE
 ETIKETTD RUCK

Battichiodo magnetico salvadito
 per chiodi piccoli e grandi

Magnetic nail holder
 for small and large nails

Sujeta clavo magnetico

Porte-clou aimanté
 pour petits et grands clous

Fingerschutz-Nagelhalter
 für kleine und große Nägel

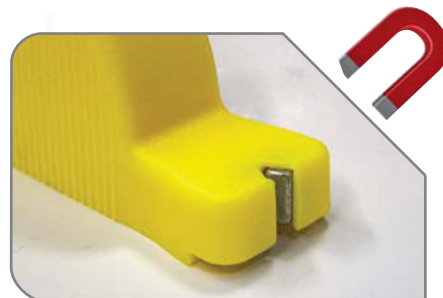

MAGNET



FINGERSAFE

| Ref. | | |
|--------|------------|-----------|
| | | NR. COLOR |
| 69997N | 21 x 35 mm | 10 |

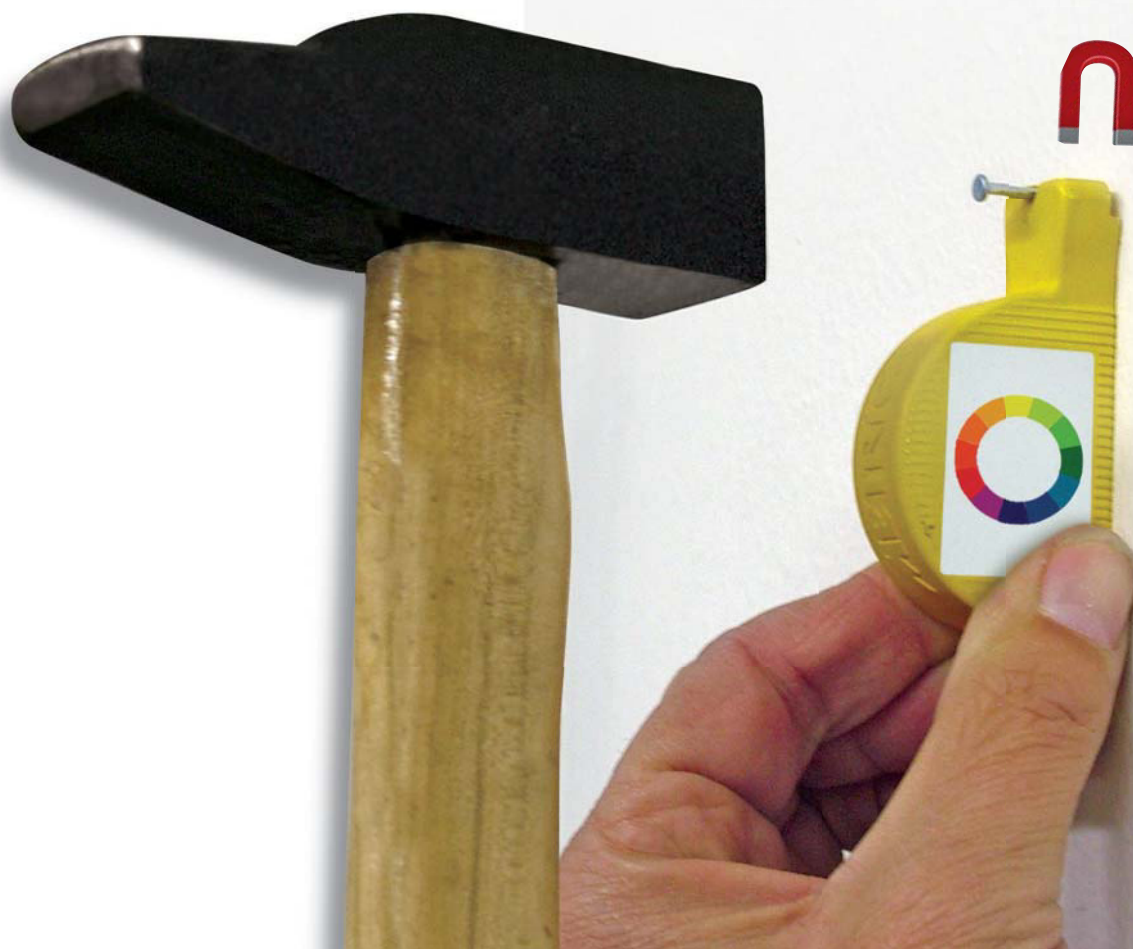

Matita All script 100% grafite
 All script pencil 100% graphite
 Lápiz All script 100% grafito
 Crayon All script 100% graphite
 All script-Stift 100% Grafit

 STAMPA DIRETTA
 DIRECT PRINTING
 IMPRESIÓN DIRECTA
 IMPRESSION DIRECTE
 DIRECKTDRUCK





100% GRAFITE



ALL SCRIPT

- | | | | | | |
|---|---|---|---|---|---|
|  |  |  |  |  |  |
| FERRO IRON FER | LEGNO WOOD BOIS | METALLO METAL MÉTAL | CARTA PAPER PAPIER | CARTONE CARDBOARD CARTON | CERAMICA CERAMIC CÉRAMIQUE |

| Ref. | L x H |  |  |
|--------|-------------|---|---|
| 51150N | 160 x 13 mm | 100 x 6 mm | NR. COLOR 1 |

Corpo in ABS rubber touch - mina nera gigante Ø 5mm
 ABS - body rubber touch - giant mine Ø 5mm
 Cuerpo de ABS - rubber touch - mina negra Ø 5mm
 Corps en ABS rubber touch - grande mine noire Ø 5mm
 ABS - Gehäuse rubber touch - schwarze Riesenmine



STAMPA DIRETTA
 DIRECT PRINTING
 IMPRESIÓN DIRECTA
 IMPRESSION DIRECTE
 DIRECKTDRUCK



| Ref. | L | | |
|-------|--------|-----------|----------------|
| 51089 | 150 mm | 60 x 3 mm | NR. COLOR 1 |

Mine di ricambio:
 Spare mines:
 Minas de recambio:
 Mines de rechange:
 Schwarze Ersatzmine:
 Cod. **51095**
 Cod. **51090**

Corpo in bachelite con pulsante in metallo
 Mina nera gigante Ø 5 mm
 Black bakelite body, metallic button
 big size Ø 5 mm
 Body negro baquelita, botón de metal Black mine
 Mina negra gigante Ø 5 mm
 Corps noir en bakélite, bouton métallique
 Grande mine noire Ø 5 mm
 Körper aus schwarzem Bakelit, Metall-Druckknopf
 Große Mine Ø 5 mm - Farbe schwarz



STAMPA DIRETTA
 DIRECT PRINTING
 IMPRESIÓN DIRECTA
 IMPRESSION DIRECTE
 DIRECKTDRUCK

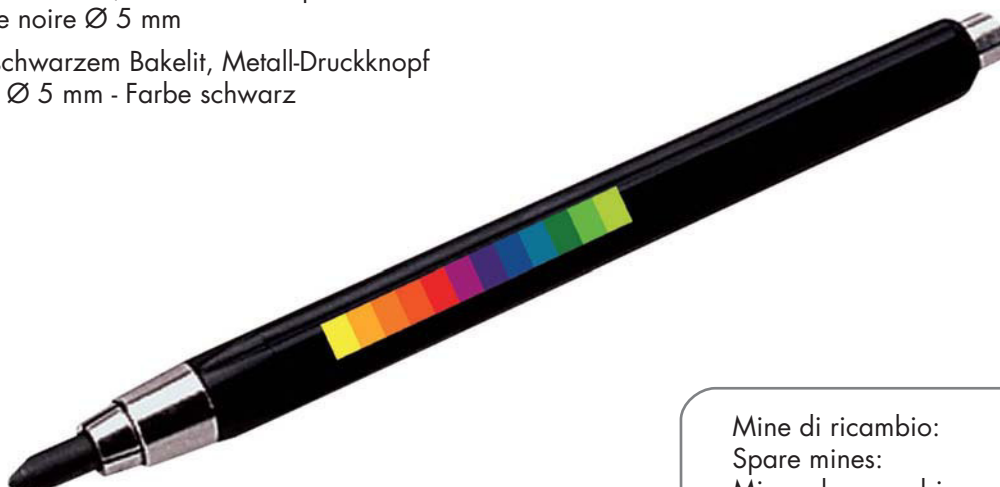

| Ref. | L | | |
|-------|--------|-----------|----------------|
| 51080 | 140 mm | 50 x 6 mm | NR. COLOR 1 |

Mine di ricambio:
 Spare mines:
 Minas de recambio:
 Mines de rechange:
 Schwarze Ersatzmine:
 Cod. **51095**
 Cod. **51090**

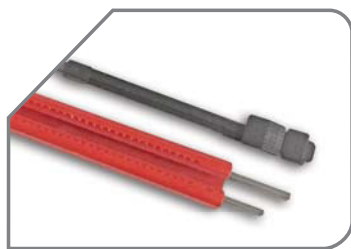

STAMPA DIRETTA
DIRECT PRINTING
IMPRÉSSION DIRECTA
IMPRESSION DIRECTE
DIRECKTDRUCK

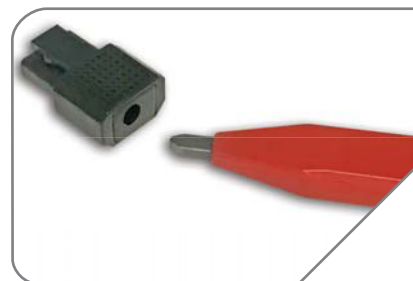

| Ref. | L | | |
|-------|--------|-----------|----------------|
| 51105 | 180 mm | 45 x 7 mm | NR. COLOR 1 |

Matita da carpentiere - corpo in ABS - temperino e portamine interno

Carpenter pencil - Abs body - Interna sharpener and mine holder

Lapiz de carpintero - cuerpo de ABS - Sacapuntas y portaminas interno

Crayon de charpentier - corps en abs - taille crayon et porte-mines interne

Zimmermannsbleistift - Gehäuse aus ABS - interner Spitzer - Minenhalter

Matitone

Big Pencil

Lapiz grande

Grand crayon

Großer Bleistift



WITH CASE

| Ref. | | L x H | | |
|-------|---|-------------|-------------|----------------|
| 51028 | ○ | 375 x 38 mm | 160 x 10 mm | NR. COLOR 1 |
| 51029 | ● | 375 x 38 mm | 160 x 10 mm | 1 |





STAMPA DIRETTA
DIRECT PRINTING
IMPRÉSSION DIRECTA
IMPRESSION DIRECTE
DIRECKTDRUCK

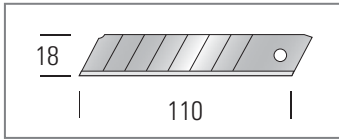

Cutter professionale bloccalama automatico
 Professional cutter self locking blade
 Chucillo profesional lama auto-bloqueante
 Couteau professionnel lame de blocage automatique
 Professionelles Messer, selbst-blockierende Klinge





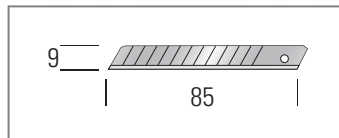

STAMPA SU ETICHETTA
 PRINTING ON STICKER
 IMPRESSION SOBRE ETIQUETA
 IMPRESSION SUR ÉTIQUETTE
 ETIKETTDRECK

| Ref. | L x H |  |  |
|-------|----------|---|---|
| | | | NR. COLOR |
| 49130 | 150 x 40 | 39 x 10 mm | 10 |

Cutters trasparenti
 Transparent cutters
 Chucillo transparente
 Couteau transparent
 Durchsichtiges Messer



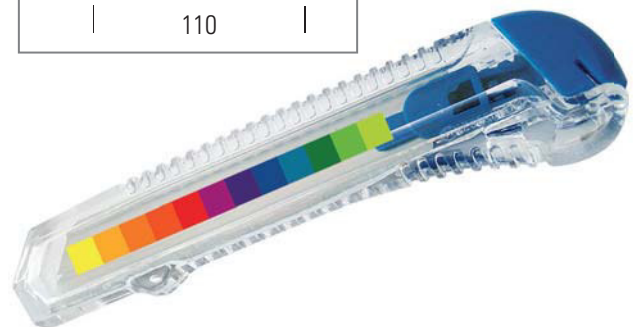
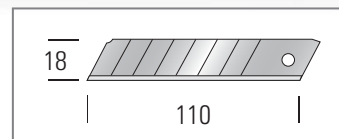

| Ref. | L x H |  |  | NR. COLOR |
|-------|----------|---|---|-----------|
| 49090 | 130 x 16 | 55 x 4,5 mm |  | 1 |
| 49091 | 130 x 16 | 55 x 4,5 mm |  | 1 |
| 49092 | 130 x 16 | 55 x 4,5 mm |  | 1 |

STAMPA DIRETTA
 DIRECT PRINTING
 IMPRESSION DIRECTA
 IMPRESSION DIRECTE
 DIRECKTDRUCK



STAMPA DIRETTA
 DIRECT PRINTING
 IMPRESSION DIRECTA
 IMPRESSION DIRECTE
 DIRECKTDRUCK

| Ref. | L x H |  |  |
|-------|----------|---|---|
| | | | NR. COLOR |
| 49095 | 150 x 40 | 80 x 7 mm | 1 |
| 49096 | 150 x 40 | 80 x 7 mm | 1 |
| 49097 | 150 x 40 | 80 x 7 mm | 1 |

Cutter per grafica
 Pocket graphic cutter
 Chucillo para grafica
 Couteau pour graphique
 Grafikermesser

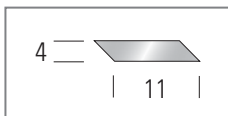

STAMPA DIRETTA
 DIRECT PRINTING
 IMPRÉSION DIRECTA
 IMPRESSION DIRECTE
 DIRECKTDRUCK

| Ref. | L x H | | NR. COLOR |
|-------|--------|-----------|-----------|
| 49052 | 140 mm | 2 x 25 mm | 1 |

Cutter metallo lama trapezoidale
 Metal body trapezoidal blade
 Cuerpo de metal cuchilla trapezoidal
 Corps en métal lame trapézoïdale
 Metallgehäuse, Trapez-Klinge

STAMPA DIRETTA
 DIRECT PRINTING
 IMPRÉSION DIRECTA
 IMPRESSION DIRECTE
 DIRECKTDRUCK

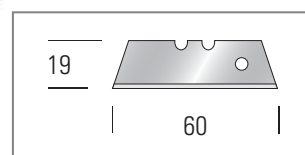

| Ref. | L x H | | NR. COLOR |
|-------|----------|------------|-----------|
| 49117 | 150 x 30 | 35 x 12 mm | 1 |

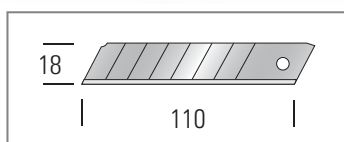

STAMPA DIRETTA
 DIRECT PRINTING
 IMPRÉSION DIRECTA
 IMPRESSION DIRECTE
 DIRECKTDRUCK

| Ref. | L x H | | NR. COLOR |
|-------|-------------|-----------|-----------|
| 49023 | 150 x 40 mm | 5 x 80 mm | 1 |

Cutter bloccalama
 Cutter metal rail
 Chucillo guía en metal
 Couteau guide de lame en métal
 Messer, Metallschiene für Klinge

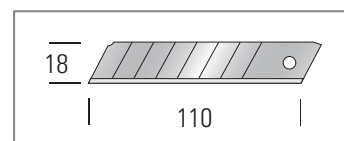

| Ref. | L x H | | NR. COLOR |
|-------|-------------|-----------|-----------|
| 49018 | 150 x 30 mm | 7 x 80 mm | 1 |

Cutter tascabile bloccalama
 Pocket cutter, safety lock
 Chucillo de bolsillo, freno de seguridad
 Couteau de poche, blocage de sécurité
 Taschen-Messer, Sicherheits-Feststellung

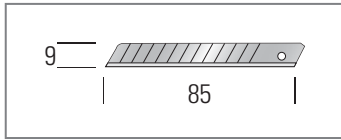

STAMPA DIRETTA
 DIRECT PRINTING
 IMPRÉSION DIRECTA
 IMPRESSION DIRECTE
 DIRECKTDRUCK

| Ref. | L x H | | |
|-------|-------------|-----------|----------------|
| 49017 | 135 x 15 mm | 5 x 49 mm | NR. COLOR 1 |

Cutter piatto in metallo. Bloccalama
 Metal body. Safety lock
 Cuerpo de metal. Freno de seguridad.
 Corps en metal. Blocage de sécurité
 Metallgehäuse. Sicherheits-Feststellung

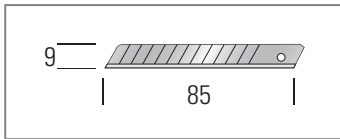

STAMPA DIRETTA
 DIRECT PRINTING
 IMPRÉSION DIRECTA
 IMPRESSION DIRECTE
 DIRECKTDRUCK

| Ref. | L x H | | |
|-------|-------------|----------|----------------|
| 49014 | 135 x 13 mm | 6 x 60mm | NR. COLOR 1 |

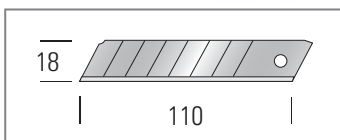

Cutter piatto in metallo bloccalama
 Metal body. Safety lock
 Cuerpo de metal. Freno de seguridad
 Corps en metal. Blocage de sécurité
 Metallgehäuse. Sicherheits-Feststellung



STAMPA DIRETTA
 DIRECT PRINTING
 IMPRÉSION DIRECTA
 IMPRESSION DIRECTE
 DIRECKTDRUCK

| Ref. | L x H | | |
|-------|-------------|------------|----------------|
| 49012 | 175 x 38 mm | 10 x 35 mm | NR. COLOR 1 |



STAMPA SU ETICHETTA
PRINTING ON STICKER
IMPRESIÓN SOBRE ETIQUETA
IMPRESSION SUR ÉTIQUETTE
ETIKETTDRUCK

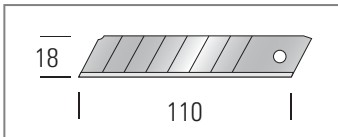

Cutter con bloccaggio
Cutter with lock
Cuchillo con bloqueo
Couteau avec blocage
Flaches Messer mit Feststellung

| Ref. | L x H | | |
|-------|-------------|------------|-----------------|
| 49035 | 160 x 45 mm | 39 x 10 mm | NR. COLOR 10 |

Apri busta
Letter opener
Abre-sobre
Ouvre-lettre
Brieföffner



STAMPA SU ETICHETTA
PRINTING ON STICKER
IMPRESIÓN SOBRE ETIQUETA
IMPRESSION SUR ÉTIQUETTE
ETIKETTDRUCK



| Ref. | L x H | | |
|-------|------------|------------|-----------------|
| 72180 | 75 x 44 mm | 23 x 52 mm | NR. COLOR 10 |

Raschietto multiuso lama retrattile
Multipurpose scraper, retractable blade
Rascador multiuso, lama retráctil
Grattoir multi-usage, lame rétractile
Mehrfunktions-Kratzer, einziehbare
Sicherheitsklinge



STAMPA SU ETICHETTA
PRINTING ON STICKER
IMPRESIÓN SOBRE ETIQUETA
IMPRESSION SUR ÉTIQUETTE
ETIKETTDRUCK

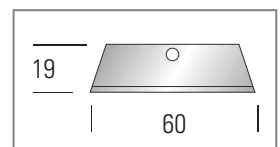

| Ref. | L x H | | |
|-------|----------|--------------|-----------------|
| 49145 | 60 x 180 | 18,5 x 74 mm | NR. COLOR 10 |

Cutter piatto di sicurezza lama retrattile a molla
 Cutter safety lock spring self retr. blade
 Cuchillo de seguridad resorte de recuperacion automatico
 Couteau de sécurité lame retractile à ressort
 Flaches Messer, Feder-Klingenrückgang

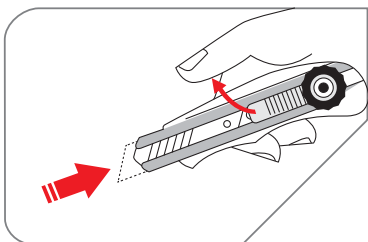

Corpo in metallo
 Metal body
 Cuerpo de metal
 Corps en métal
 Metallgehäuse

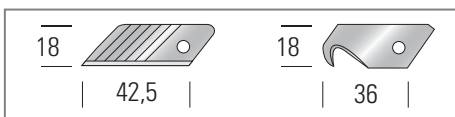
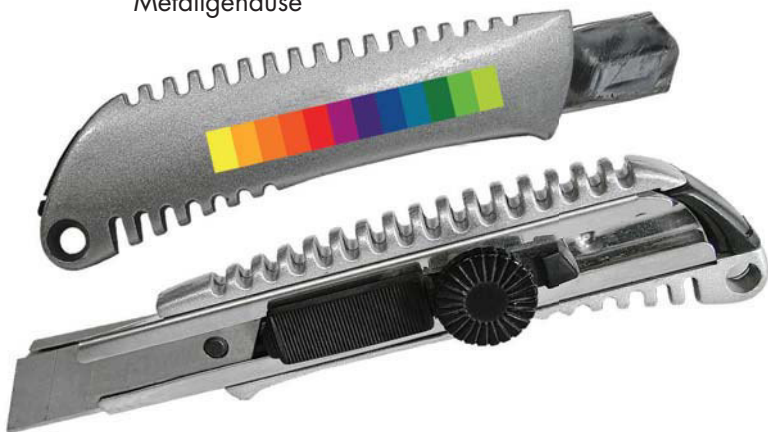
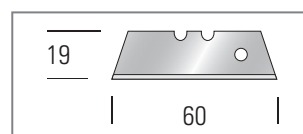

| Ref. | L x H | | NR. COLOR |
|-------|-------------|------------|-----------|
| 49121 | 155 x 40 mm | 70 x 10 mm | 1 |

| Ref. | L x H | | NR. COLOR |
|-------|-------------|------------|-----------|
| 49001 | 125 x 29 mm | 60 x 13 mm | 1 |



STAMPA DIRETTA
 DIRECT PRINTING
 IMPRESSION DIRECTA
 IMPRESSION DIRECTE
 DIRECKTDRUCK

Cutter piatto di sicurezza lama retrattile a molla
 Cutter safety lock spring, self retr. blade
 Cuchillo de seguridad, resorte de recuperacion automatico
 Couteau de sécurité, lame retractile à ressort
 Flaches Messer, Feder-Klingenrückgang

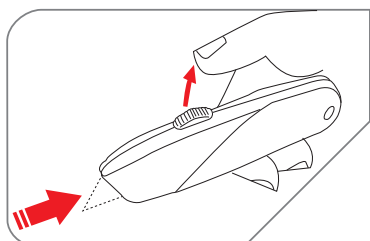

STAMPA DIRETTA
 DIRECT PRINTING
 IMPRESSION DIRECTA
 IMPRESSION DIRECTE
 DIRECKTDRUCK

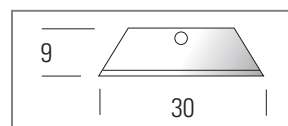

| Ref. | L x H | | NR. COLOR |
|-------|------------|-----------|-----------|
| 49000 | 80 x 17 mm | 30 x 5 mm | 1 |

Portachiavi
Key-holder
Llaveros
Porte-clès
Schlüsselanhänger



STAMPA DIRETTA
DIRECT PRINTING
IMPRÉSSION DIRECTA
IMPRESSION DIRECTE
DIRECKTDRUCK



| Ref. | | | |
|--------------|--|-----------|------------------|
| | | | |
| | | | NR. COLOR |
| 33015 | | 7 x 25 mm | 1 |
| 33020 | | 7 x 25 mm | 1 |



STAMPA SU ETICHETTA
PRINTING ON STICKER
IMPRÉSSION SOBRE ETIQUETA
IMPRESSION SUR ÉTIQUETTE
ETIKETTDRUCK



| Ref. | L | | | |
|--------------|-----|-------|------------|------------------|
| | | | | |
| | | | | NR. COLOR |
| 38045 | 2 m | mm/mm | 30 x 30 mm | 10 |

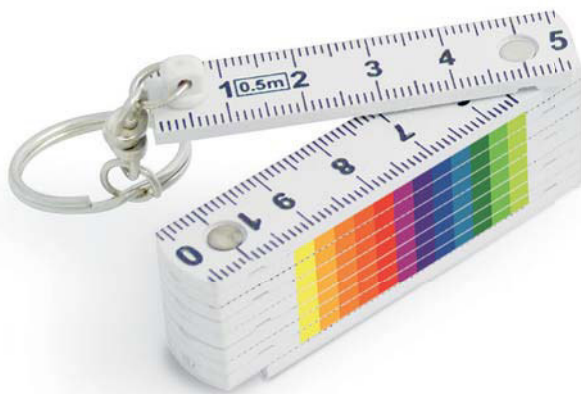

| Ref. | L | | | |
|--------------|--------|----|------------|------------------|
| | | | | |
| | | | | NR. COLOR |
| 18800 | 0,50 m | mm | 14 x 43 mm | 1 |



| Ref. | L | | | |
|--------------|-----|----|---------|------------------|
| | | | | |
| | | | | NR. COLOR |
| 38008 | 1 m | mm | Ø 21 mm | 10 |

Cristallo ottico da tavolo con led
 Optical crystal table with led
 Optica de cristal de mesa con led
 Cristal optique de table avec lumière
 Kristall-Lupe mit LED-Leuchte, Tisch-Format



STAMPA DIRETTA
 DIRECT PRINTING
 IMPRESSION DIRECTA
 IMPRESSION DIRECTE
 DIRECKTDRUCK

**ESTRAIBILE
 EXTRACTABLE
 EXTRAÍBLE
 EXTRACTIBLE
 AUSZIEHBAR**

| Ref. | H | | | | |
|-------|--------|----|------------|-----------|-----------|
| | | | A | B | NR. COLOR |
| 49490 | 140 mm | 2X | 12 x 45 mm | 8 x 45 mm | 1 |



Cristallo ottico da tavolo con led
 manico gommato
 Crystal lens with led
 Lente en cristal con led
 Lentille en cristal avec lumière
 Kristall-Lupe mit LED-Leuchte u. gummiertem Griff



 STAMPA DIRETTA
 DIRECT PRINTING
 IMPRESSION DIRECTA
 IMPRESSION DIRECTE
 DIRECKTDRUCK

LED





| Ref. |  |  |  |
|-------|---|---|---|
| | | | NR. COLOR |
| 49494 | 2 X | 20 x 6 mm | 1 |



 STAMPA DIRETTA
 DIRECT PRINTING
 IMPRESSION DIRECTA
 IMPRESSION DIRECTE
 DIRECKTDRUCK

LED



| Ref. |  |  |  |
|-------|---|---|---|
| | | | NR. COLOR |
| 49492 | 2 X | 20 x 6 mm | 1 |



STAMPA DIRETTA
DIRECT PRINTING
IMPRESSION DIRECTA
IMPRESSION DIRECTE
DIRECKTDRUCK



Cristallo ottico - manico piatto - ingrandimento 3X
Cristal lens - flat handle - magnification 3X
Lente en cristal - aumento 3X
Lentille en cristal - poignée plate - grossissement 3X
Kristall-Lupe - Vergrößerung 3X

| Ref. | | | |
|--------------|-----|------------|-----------------------|
| 49497 | 3 X | 50 x 10 mm | NR. COLOR 1 |



Lente acrilica bifocale - ingrandimento 2,5X - 5X
Bifocal magnifier - acrylic lens - magnification 2,5X - 5X
Lupa bifocal - lente acrilico - aumento 2,5X - 5X
Loupe bifocale - lentille acrylique - grossissement 2,5X - 5X
Bifocal-Lupe - Acryl-Linse - Vergrößerung 2,5X - 5X

| Ref. | | | |
|--------------|-----------|-----------|-----------------------|
| 49498 | 2 X - 5 X | 50 x 4 mm | NR. COLOR 1 |



Cristallo ottico - custodia in semipelle
Cristal lens - similar leather
Lente en cristal - cuero similares
Lentille en cristal - étui sinili cuir
Kristall-Taschenlupe, Etui aus Kunstleder

| Ref. | | | |
|--------------|-------|---------|-----------------------|
| 49510 | 3,5 X | Ø 35 mm | NR. COLOR 1 |



STAMPA DIRETTA
DIRECT PRINTING
IMPRÉSION DIRECTA
IMPRESSION DIRECTE
DIRECKTDRUCK



| Ref. | | | |
|-------|-----|------------|----------------|
| 49565 | 5 X | 15 x 25 mm | NR. COLOR 1 |



STAMPA DIRETTA
DIRECT PRINTING
IMPRÉSION DIRECTA
IMPRESSION DIRECTE
DIRECKTDRUCK

Contafili a libro - plastica nera
Foldable linen Abs
Cuenta-hilos - ABS negro
Compte-fils - ABS noir
Ausklappbarer Fadenzähler - ABS



| Ref. | | | |
|-------|-----|-----------|----------------|
| 49585 | 6 X | 5 x 10 mm | NR. COLOR 1 |



| Ref. | | | |
|-------|------|-----------|----------------|
| 49562 | 12 X | 5 x 10 mm | NR. COLOR 1 |



| Ref. | | | |
|-------|-----|------------|----------------|
| 49550 | 8 X | 21 x 21 mm | NR. COLOR 1 |



| Ref. | L | | | NR. COLOR |
|---------|------|-------|--|-----------|
| 40016SP | 10 m | 16 mm | | 10 |
| 40017SP | 20 m | 16 mm | | 10 |

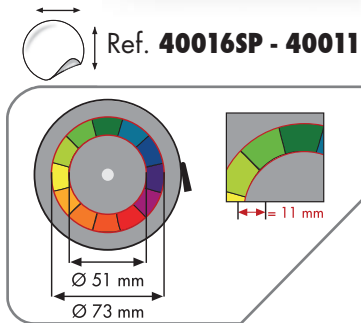

STAMPA SU ETICHETTA
PRINTING ON STICKER
IMPRESIÓN SOBRE ETIQUETA
IMPRESSION SUR ÉTIQUETTE
ETIKETTDROCK



| Ref. | L | | | NR. COLOR |
|-------|------|-------|--|-----------|
| 40011 | 10 m | 16 mm | | 10 |
| 40013 | 20 m | 16 mm | | 10 |

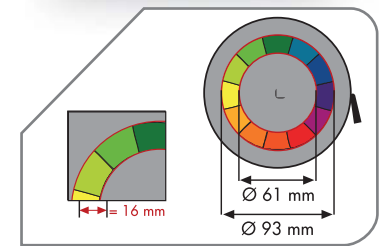

Ref. **40017SP - 40013**



Stampa diretta
Direct printing
Impresión directa
Impression directe
Direcktdruck

r = 45 mm

Fibra di vetro - grad. cm
custodia in metallo rivestita in skay

Fiberglass tape - grad. cm
metal case yellow similar leather covered

Fibra de vidrio - grad. cm caja amarillo de metal cubierta en simil-cuero

Fibre de verre - grad. cm boîtier jaune en métal revêtu en simil-cuir

Glasfaserbandmaße - Teil. cm Kunstleder überzogene Metallkapsel-gelb

| Ref. | L | | | NR. COLOR |
|---------|------|-------|--|-----------|
| 40143SP | 20 m | 16 mm | | 1 |

Matite falegname - 144 pz
 Carpenter pencils - 144 pcs
 Lapizes de carpintero - 144 pzs
 Crayons pour charpentier - 144 pcs
 Zimmermannsbleistifte - 144 Stk

HIGH QUALITY



STAMPA DIRETTA
 DIRECT PRINTING
 IMPRESSION DIRECTA
 IMPRESSION DIRECTE
 DIRECKTDRUCK

Superficie di stampa diretta
 Direct Printing surface
 Surface d'impression directa
 Superficie d'impression directe
 Fläche für Direktdruck

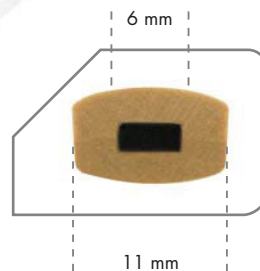

Larghezza matita
 Pencil width
 Ancho de un lápiz
 Largeur de crayon
 Bleistift Breite

| Ref. | | L | | |
|--------|---|--------|------------|-------------|
| 51001N | ● | 180 mm | 160 x 6 mm | NR. COLOR 1 |
| 51002N | ● | 180 mm | 160 x 6 mm | NR. COLOR 1 |
| 51003N | ● | 180 mm | 160 x 6 mm | NR. COLOR 1 |
| 51004N | ● | 180 mm | 160 x 6 mm | NR. COLOR 1 |
| 51005N | ○ | 180 mm | 160 x 6 mm | NR. COLOR 1 |

| Ref. | | L | | |
|--------|---|--------|------------|-------------|
| 51010N | ● | 240 mm | 160 x 6 mm | NR. COLOR 1 |
| 51011N | ● | 240 mm | 160 x 6 mm | NR. COLOR 1 |
| 51012N | ○ | 240 mm | 160 x 6 mm | NR. COLOR 1 |
| 51013N | ● | 240 mm | 160 x 6 mm | NR. COLOR 1 |
| 51020N | ● | 300 mm | 160 x 6 mm | NR. COLOR 1 |

Matite per marmista - 144 pz.
 Marble pencil - 144 pcs
 Lapizes de marbolista - 144 pzs
 Crayons de maçon - 144 pcs
 Steinbleistifte - 144 Stk

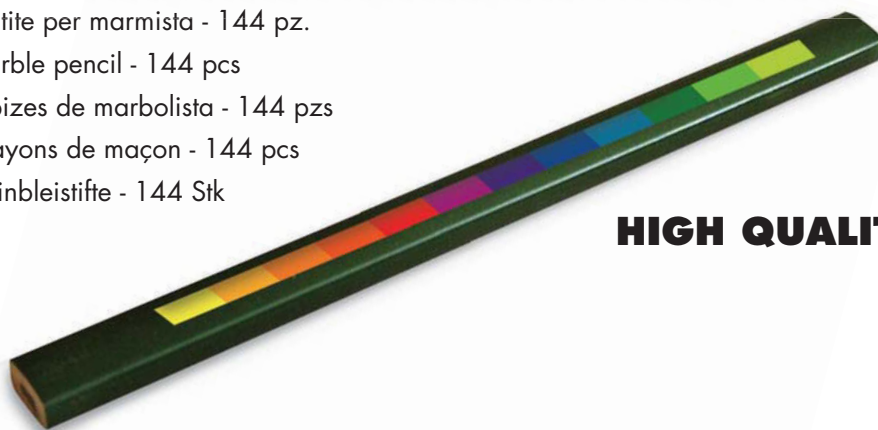

HIGH QUALITY

Superficie di stampa diretta
 Direct Printing surface
 Surface d'impression directa
 Superficie d'impression directe
 Fläche für Direktdruck

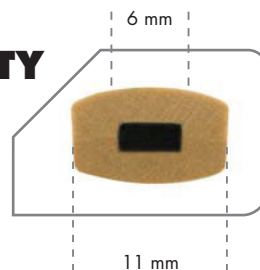

Larghezza matita
 Pencil width
 Ancho de un lápiz
 Largeur de crayon
 Bleistift Breite

| Ref. | | L | | |
|--------|---|--------|------------|-------------|
| 51060N | ● | 240 mm | 160 x 6 mm | NR. COLOR 1 |
| 51070N | ● | 300 mm | 160 x 6 mm | NR. COLOR 1 |

STAMPA DIRETTA
 DIRECT PRINTING
 IMPRESSION DIRECTA
 IMPRESSION DIRECTE
 DIRECKTDRUCK

Matite falegname - 144 pz
 Carpenter pencils - 144 pcs
 Lapizes de carpintero - 144 pzs
 Crayons pour charpentier - 144 pcs
 Zimmermannsbleistifte - 144 Stk



STAMPA DIRETTA
 DIRECT PRINTING
 IMPRÉSION DIRECTA
 IMPRESSION DIRECTE
 DIRECKTDRUCK

| Ref. | | L | | NR. COLOR |
|--------|---|--------|------------|-----------|
| 50419N | ● | 180 mm | 160 x 6 mm | 1 |
| 50440N | ● | 180 mm | 160 x 6 mm | 1 |
| 50441N | ○ | 180 mm | 160 x 6 mm | 1 |
| 50442N | ● | 180 mm | 160 x 6 mm | 1 |

| Ref. | | L | | NR. COLOR |
|--------|---|--------|------------|-----------|
| 50451N | ○ | 240 mm | 160 x 6 mm | 1 |
| 50452N | ● | 240 mm | 160 x 6 mm | 1 |
| 51018N | ● | 240 mm | 160 x 6 mm | 1 |

Matite per marmista - 144 pz.
 Marble pencil - 144 pcs
 Lapizes de marbolista - 144 pzs
 Crayons de maçon - 144 pcs
 Steinbleistifte - 144 Stk

| Ref. | | L | | NR. COLOR |
|----------|---|-------------|------------|-----------|
| 51060ANN | ● | 240 x 11 mm | 160 x 6 mm | 1 |

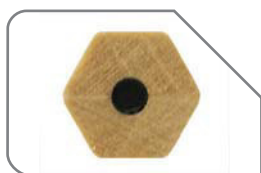

51510N



Matite naturali
 Natural pencils
 Carpintero natural
 Crayons naturels
 Naturbleistifte



| Ref. | | L | | NR. COLOR |
|--------|---|----|-----------|-----------|
| 51510N | ● | 80 | 40 x 2 mm | 1 |

STAMPA DIRETTA
 DIRECT PRINTING
 IMPRÉSION DIRECTA
 IMPRESSION DIRECTE
 DIRECKTDRUCK

Livella due fiale, 20 cm, manici in gomma
 Level with 2 vials, 20 cm, rubber handles
 Nivel con 2 burbujas, 20 cm, manejas de goma
 Niveau avec 2 fioles, 20 cm, poignées en caoutchouc
 Wasserwaage mit 2 Libellen, 20 cm, Gummi-Griffe



STAMPA DIRETTA
 DIRECT PRINTING
 IMPRESSION DIRECTA
 IMPRESSION DIRECTE
 DIRECKTDRUCK

| Ref. | | | NR. COLOR |
|-------|------------|--|-----------|
| 31025 | 12 x 80 mm | | 1 |

Minilivella tascabile a 1 fiala - 10 cm
 Mini pocket-level with 1 vial - 10 cm
 Mini nivel con 1 burbuja - 10 cm
 Mini-niveau de poche avec 1 fiole - 10 cm
 Mini Taschen-Wasserwaage mit 1 Libelle - 10 cm



STAMPA DIRETTA
 DIRECT PRINTING
 IMPRESSION DIRECTA
 IMPRESSION DIRECTE
 DIRECKTDRUCK



| Ref. | | | NR. COLOR |
|--------|-----------|--|-----------|
| 31021N | 5 x 90 mm | | 1 |



STAMPA DIRETTA
 DIRECT PRINTING
 IMPRESSION DIRECTA
 IMPRESSION DIRECTE
 DIRECKTDRUCK



Livella plexiglass trasparente
 a 2 fiale 9,5 x 5 cm
 Transparent Plexiglass level
 with 2 vials - 9,5 x 5 cm
 Nivel de plexiglas transparente
 con 2 burbujas - 9,5 x 5 cm
 Niveau en plexiglas transparent
 avec 2 fioles - 9,5 x 5 cm
 Plexiglas-Wasserwaage, durchsichtig,
 mit 2 Libellen - 9,5 x 5 cm

| Ref. | | | | NR. COLOR |
|-------|------------|------------|--|-----------|
| 33031 | 15 x 60 mm | 25 x 30 mm | | 1 |

Livella - 2 fiale
 Level - 2 vials
 Nivel - 2 burbujas
 Niveau - 2 fioles
 Wasserwaage - 2 Libellen



STAMPA DIRETTA
 DIRECT PRINTING
 IMPRESSION DIRECTA
 IMPRESSION DIRECTE
 DIRECKTDRUCK

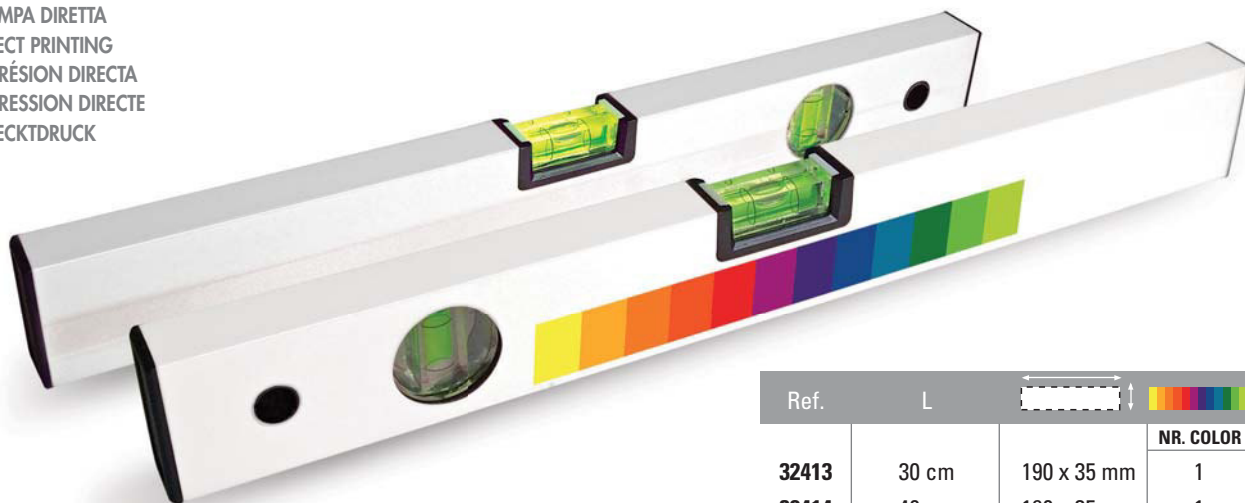

| Ref. | L | | NR. COLOR |
|-------|-------|-------------|-----------|
| 32413 | 30 cm | 190 x 35 mm | 1 |
| 32414 | 40 cm | 190 x 35 mm | 1 |
| 32415 | 50 cm | 190 x 35 mm | 1 |

Livella tascabile ABS - 105 mm - 2 fiale
 Pocket ABS level - 105 mm - 2 vials
 Nivel de bolsillo - - 105 mm - resina acrilica - 2 burbujas
 Niveau de poche en ABS - 105 mm - 2 fioles
 Taschen ABS-Wasserwaage - 105 mm - 2 Libellen



| Ref. | | | NR. COLOR |
|-------|--|------------|-----------|
| 33090 | | 75 x 10 mm | 1 |
| 33091 | | 75 x 10 mm | 1 |
| 33092 | | 75 x 10 mm | 1 |
| 33093 | | 75 x 10 mm | 1 |
| 33094 | | 75 x 10 mm | 1 |



STAMPA DIRETTA
 DIRECT PRINTING
 IMPRESSION DIRECTA
 IMPRESSION DIRECTE
 DIRECKTDRUCK

- 1 Metro ad asta in legno grad. cm
- 1 Taylor's wooden rule grad. cm
- 1 Metro para sastre madera grad. cm
- 1 Mètre de couturier bois grad. cm
- 1 Holz-Schneidmaßtab cm Teilung

A

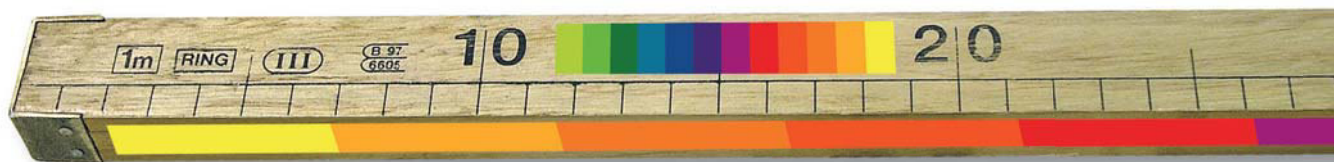

B



STAMPA DIRETTA
DIRECT PRINTING
IMPRÉSION DIRECTA
IMPRESSION DIRECTE
DIRECKTDRUCK

| Ref. | A | B | NR. COLOR |
|-------|------------|-------------|-----------|
| 22071 | 70 x 10 mm | 1 m x 15 mm | 1 |

Inclinometro a quadrante
Slope level
Nivel de inclinaciones
Niveau pour inclinaison
Neigungswasserwaage



STAMPA SU ETICHETTA
PRINTING ON STICKER
IMPRÉSSION SOBRE ETIQUETA
IMPRESSION SUR ÉTIQUETTE
ETIKETTDRUCK

| Ref. | A | NR. COLOR |
|-------|---------|-----------|
| 33270 | Ø 30 mm | 10 |



STAMPA SU ETICHETTA
 PRINTING ON STICKER
 IMPRESIÓN SOBRE ETIQUETA
 IMPRESSION SUR ÉTIQUETTE
 ETIKETTDRUCK



Metro per sarto - Rientro automatico
 Taylor's tape - Automatic return
 Metro para sastre - Retorno automático
 Mètre de couturier - Retour automatique
 Schneidermaßband - Automatischer Rücklauf

| Ref. | L | Scale | Diagram | Color Ring | NR. COLOR |
|-------|-------|-------|---------|------------|-----------|
| 22110 | 1,5 m | cm/cm | Ø 25 mm | | 10 |



STAMPA DIRETTA
 DIRECT PRINTING
 IMPRESIÓN DIRECTA
 IMPRESSION DIRECTE
 DIRECKTDRUCK

Diametrometro
 Anatomic gauge
 Para medidas anatomicas
 Pour mesures anatomiques
 Anatomisches Messgerät



| Ref. | L | Diagram | | Color Bar | NR. COLOR |
|-------|-------|------------|------------|-----------|-----------|
| | | FRONT | BACK | | |
| 22130 | 1,5 m | 45 x 25 mm | 30 x 10 mm | | 1 |

Metro per sarto
 Taylor's tape
 Metro para sastre
 Mètre de couturier
 Schneidermaßband, zweifarbig



| Ref. | L | Diagram | Color Bar | NR. COLOR |
|-------|-------|------------|-----------|-----------|
| 22090 | 1,5 m | 60 x 10 mm | | 1 |



Nastro in carta
 Paper tape
 Cinta en papel
 Ruban en papier
 Papierband





| Ref. | L | Diagram | Color Bar | NR. COLOR |
|-------|-------|------------|-----------|-----------|
| 39905 | 95 cm | 95 x 20 mm | | 1 |

Misuratore di profondità per battistrada
 Tyre profile depth gauge - stainless steel
 Medidor de profundidad para pneumaticos
 acero inox
 Jauge de profondeur pour pneu - acier inox
 Reifenprofilmesser rostfreier Stahl



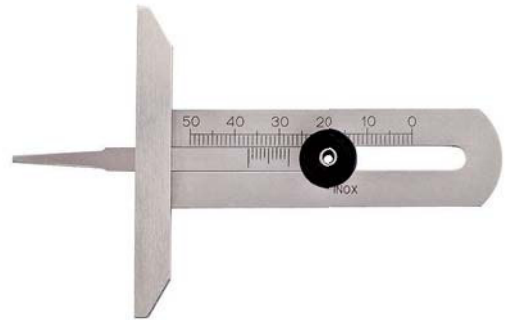

| Ref. | A |  |  |
|--------------|---------|---|---|
| 10820 | 0-30 mm | 25 x 4,5 mm | NR. COLOR 1 |

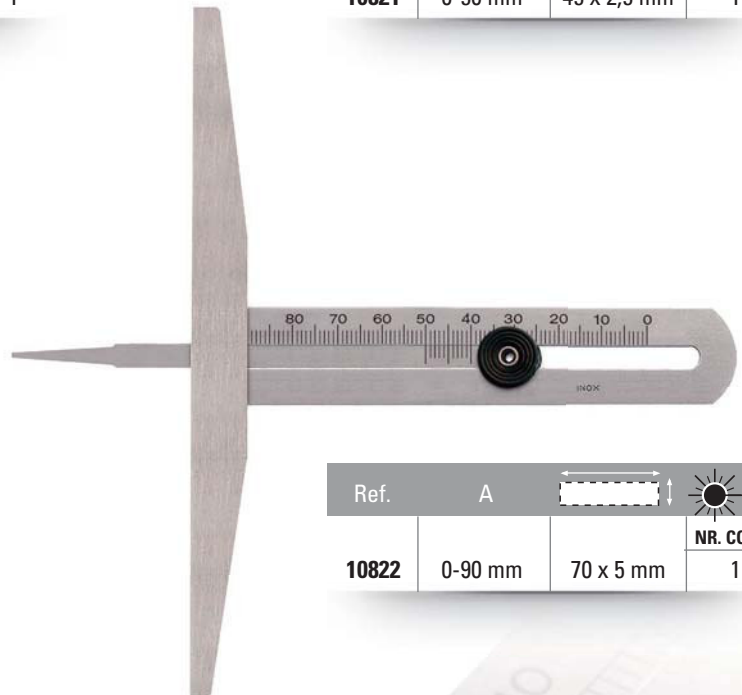

| Ref. | A |  |  |
|--------------|---------|---|---|
| 10821 | 0-50 mm | 45 x 2,5 mm | NR. COLOR 1 |



| Ref. | A |  |  |
|--------------|---------|---|---|
| 10822 | 0-90 mm | 70 x 5 mm | NR. COLOR 1 |



STAMPA LASER
 LASER MONOCHROME LOGO
 LASER MONOCROME LOGOTIPO
 LASER LOGO MONOCHROMÉ
 LASER MONOCHROM-LOGO

Calibro in plastica - lettura 1/10 mm
 ABS vernier caliper - reading 1/10 mm
 Calibre de plastic - lectura 1/10 mm
 Pied à coulisse en ABS - lecture 1/10 mm
 ABS Messschieber - Ablesung 1/10 mm



STAMPA DIRETTA
 DIRECT PRINTING
 IMPRÉSION DIRECTA
 IMPRESSION DIRECTE
 DIRECKTDRUCK

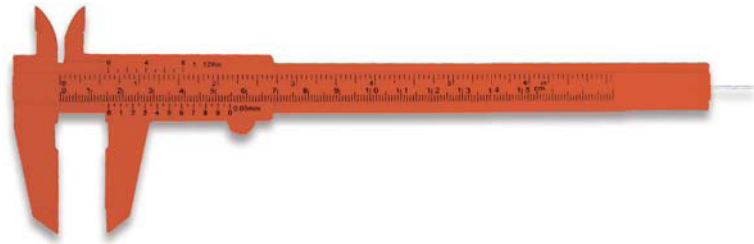

| Ref. | Cap. | | |
|--------------|----------|-----------|-----------------------|
| 10723 | 0-150 mm | 25 x 6 mm | NR. COLOR 1 |



| Ref. | Cap. | | |
|--------------|----------|-----------|-----------------------|
| 10722 | 0-150 mm | 25 x 6 mm | NR. COLOR 1 |



STAMPA LASER
 LASER MONOCHROME LOGO
 LASER MONOCROME LOGOTIPO
 LASER LOGO MONOCHROMÉ
 LASER MONOCHROM-LOGO

Calibro tascabile - in acciaio - lettura 1/20 mm
 Pocket vernier caliper - reading 1/20 mm
 Calibre de bolsillo - lectura 1/20 mm
 Pied à coulisse de poche - lecture 1/20 mm
 Taschen-Messschieber - Ablesung 1/20 mm

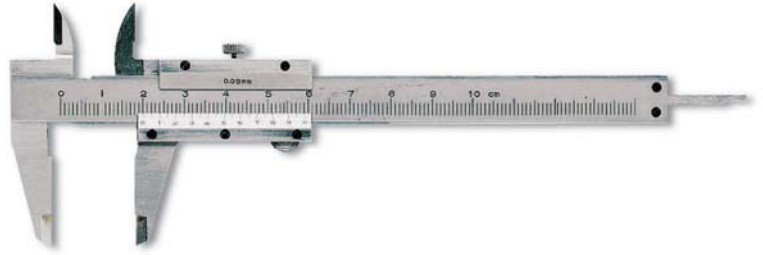

| Ref. | A | | |
|---------------|----------|-----------|-----------------------|
| 10011N | 0-100 mm | 30 x 6 mm | NR. COLOR 1 |



Calibro per bottoni - In ottone
 Button slide caliper - brass
 Calibre a botón
 Pied à coulisse à bouton - laiton
 Knopfmaß - Messing

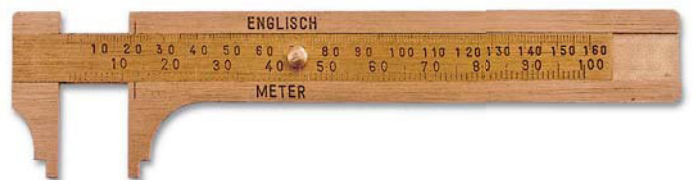

| Ref. | A | | |
|--------------|----------|-----------|-----------------------|
| 10801 | 0-100 mm | 10 x 3 mm | NR. COLOR 1 |

- Misuratore di distanza a raggi laser - 30 m
- Metrolaser, Electronic distance measure, visible laser - 30 m
- Metrolaser, mesure électronique de distance - 30 m
- Medidor laser automatico - 30 m
- Metrolaser, sichtbarer Laserstrahl - 30 m

30 m



STAMPA DIRETTA
DIRECT PRINTING
IMPRÉSION DIRECTA
IMPRESSION DIRECTE
DIRECKTDRUCK

| Ref. | L x H | P | | |
|--------------|-------------|------|-----------|-----------------------|
| 61130 | 120 x 48 mm | 30 m | 80 x 8 mm | NR. COLOR 1 |

- Misuratore di distanza a raggi laser - 50 m
- Metrolaser, Electronic distance measure, visible laser - 50 m
- Metrolaser, mesure électronique de distance - 50 m
- Medidor laser automatico - 50 m
- Metrolaser, sichtbarer Laserstrahl - 50 m

50 m



STAMPA DIRETTA
DIRECT PRINTING
IMPRÉSION DIRECTA
IMPRESSION DIRECTE
DIRECKTDRUCK

| Ref. | L x H | P | | |
|--------------|------------|------|-----------|-----------------------|
| 61150 | 97 x 96 mm | 50 m | 80 x 8 mm | NR. COLOR 1 |

Misuratore di spessore lettura 0,1 mm
 Dial thickness gauge, reading 0,1 mm
 Medidor de espesor de cuadrante, lect. 0,1 mm
 Jauge d'épaisseur à cadran, lecture 0,1 mm
 Dickenmeßgerät, Ablesung 0,1 mm



| Ref. | C x P | | NR. COLOR |
|-------|------------|-----------|-----------|
| 43052 | 20 x 20 mm | 21 x 7 mm | 1 |
| 43053 | 20 x 50 mm | 21 x 7 mm | 1 |



STAMPA DIRETTA SUL QUADRANTE
 DIRECT PRINTING ON THE DIAL
 IMPRESIÓN DIRECTA SOBRE EL CUADRANTE
 IMPRESSION DIRECTE SUR LE CADRAN
 DIRECKTDRUCK AUF DEN ZIFFERNBLATT

Misuratore di spessore a quadrante con leva lett. 0,1 mm
 Dial thickness gauge, reading 0,1 mm lifting lever
 Medidor de espesor de cuadrante decimal, lect. 0,1 mm
 Jauge d'épaisseur à cadran, lecture 0,1 mm avec levier
 Uhr-Dickenmeßgerät, Ablesung 0,1 mm Abhebevorrichtung



| Ref. | C x P | | NR. COLOR |
|-------|-------------|-----------|-----------|
| 43055 | 30 x 200 mm | 21 x 7 mm | 1 |
| 43056 | 30 x 300 mm | 21 x 7 mm | 1 |

Misuratore profondità battistrada lettura 0,1 mm
 Dial depth gauge for tyre, reading 0,1 mm
 Medidor de espesor de cuadrante para pneumaticos, lect. 0,1 mm
 Jauge de profondeur à cadran pour pneu, lecture 0,1 mm
 Reifen-Uhrmeßgerät, Ablesung 0,1 mm



| Ref. | A | | NR. COLOR |
|-------|---------|-----------|-----------|
| 43140 | 0-20 mm | 21 x 7 mm | 1 |



STAMPA CON CLICHÉ SUL RETRO
 PRINTING WITH CLICHÉ ON THE BACK
 IMPRESIÓN CON CLICHÉ EN LA PARTE POSTERIOR
 IMPRESSION AVEC CLICHÉ À L'ARRIÈRE
 DRUCK MIT KLISCHEE AUF DER RÜCKSEITE

Su richiesta disponibili in differenti
 misure e graduazioni

On demande, different sizes and
 graduations available

A demanda hay otras medidas
 y graduaciones

Sur demande d'autres longueurs
 et graduations sont disponibles

Auf Anfrage sind andere Längen
 und Teilungen verfügbar

Riga acciaio inox - 20 x 0,5 mm

Stainless steel - 20 x 0,5 mm

Regla acero inox - 20 x 0,5 mm

Règle acier inox - 20 x 0,5 mm

Maßstab, rostfreier Stahl - 20 x 0,5 mm



| Ref. | L. | mm/mm |  NR. COLOR |
|-------|-------|-------|--|
| 24070 | 15 cm | mm/mm | 1 |

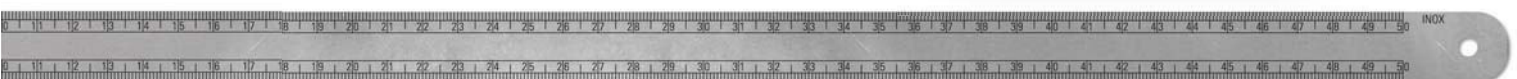

| Ref. | L. | mm/mm |  NR. COLOR |
|-------|-------|---------|--|
| 24072 | 50 cm | mm/mm | 1 |
| 24075 | 50 cm | mm/½mm | 1 |
| 24092 | 50 cm | mm/inch | 1 |

NEW GRADUATION

Riga acciaio inox
con graduazione a lettura facilitata

Stainless steel with graduation
for easy reading

Regla acero inox con graduación
a lectura simplificada

Règle acier inox avec graduation
pour lecture facilitée

Maßstab, rostfreier Stahl mit Teilung
für vereinfachtes Ablesen

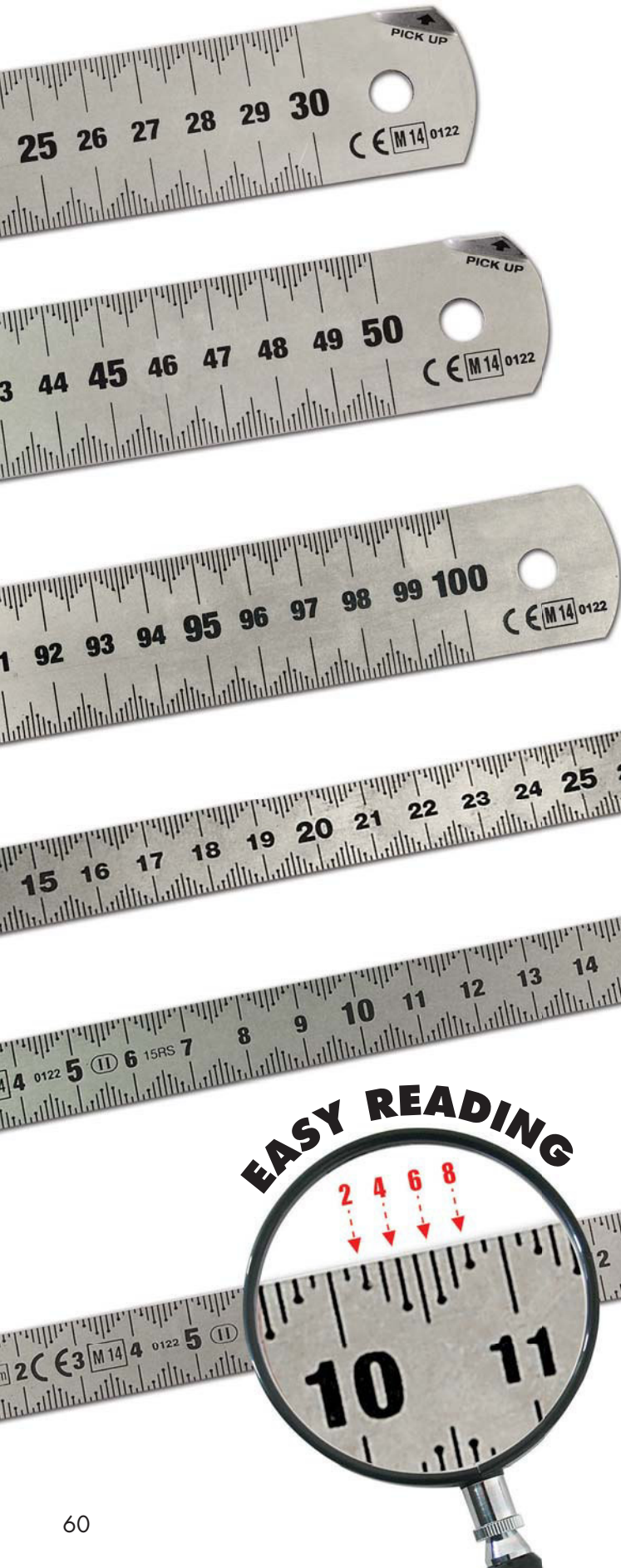

| Ref. | L | A x B | mm |  |
|-------|--------|-------------|----|---|
| 24300 | 15 cm | 15 x 0,5 mm | mm | NR. COLOR 1 |
| 24301 | 20 cm | 15 x 0,5 mm | mm | 1 |
| 24303 | 30 cm | 15 x 0,5 mm | mm | 1 |
| 24320 | 30 cm | 30 x 1 mm | mm | 1 |
| 24321 | 50 cm | 30 x 1 mm | mm | 1 |
| 24322 | 100 cm | 30 x 1 mm | mm | 1 |



STAMPA CON CLICHÉ SUL RETRO
PRINTING WITH CLICHÉ ON THE BACK
IMPRESIÓN CON CLICHÉ EN LA PARTE POSTERIOR
IMPRESSION AVEC CLICHÉ À L'ARRIÈRE
DRUCK MIT KLISCHEE AUF DER RÜCKSEITE

PICK UP

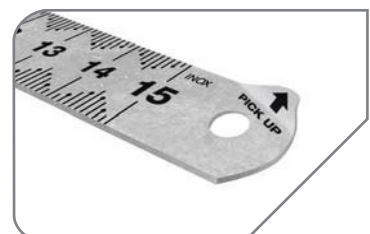

Riga acciaio inox - 13 x 0,4 mm
 Stainless steel - 13 x 0,4 mm
 Acero inox - 13 x 0,4 mm
 Règle acier inox - 13 x 0,4 mm
 Rostfreier Stahl - 13 x 0,4 mm



STAMPA CON CLICHÉ SUL RETRO
 PRINTING WITH CLICHÉ ON THE BACK
 IMPRESIÓN CON CLICHÉ EN LA PARTE POSTERIOR
 IMPRESSION AVEC CLICHÉ À L'ARRIÈRE
 DRUCK MIT KLISCHEE AUF DER RÜCKSEITE

| Ref. | L. | |  NR. COLOR |
|--------------|-------|---------|--|
| 24052 | 20 cm | mm/mm | 1 |
| 24054 | 30 cm | mm/mm | 1 |
| 24032 | 20 cm | mm/½mm | 1 |
| 24034 | 30 cm | mm/½mm | 1 |
| 24012 | 20 cm | mm/inch | 1 |
| 24014 | 30 cm | mm/inch | 1 |

Tipometro 4 scale acciaio inox - 20 x 0,5 mm
 Stainless steel typescale - 4 scale - 20 x 0,5 mm
 Tipometro acero inox - 4 escalas - 20 x 0,5 mm
 Règle pour imprimeur en acier inox - 4 échelles - 20 x 0,5 mm
 Setzer-Maßstab aus rostfreiem Stahl - 4 Skalen - 20 x 0,5 mm

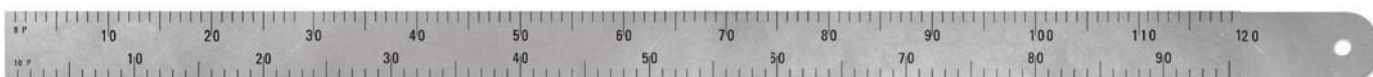

| Ref. | L. | |  NR. COLOR |
|--------------|-------|--------|--|
| 24123 | 36 cm | mm/pti | 1 |

Riga acciaio inox - 30 x 1 mm
 Stainless steel semi-stiff rule - 30 x 1 mm
 Regla en acero inox semi-rigido - 30 x 1 mm
 Reglet semirigide en acier inox - 30 x 1 mm
 Halbstarrer Maßstab aus rostfreiem Stahl - 30 x 1 mm



| Ref. | L. | |  NR. COLOR |
|--------------|-------|--------|--|
| 25101 | 30 cm | mm/mm | 1 |
| 25102 | 50 cm | mm/mm | 1 |
| 25121 | 30 cm | mm/½mm | 1 |
| 25122 | 50 cm | mm/½mm | 1 |

Scalimetro in metallo, 5 scale, 30 cm
 3-sided rule, 5 scales, 30 cm
 Regla 3 lados, 5 escalas, 30 cm
 Règle catch 3 cotés, 5 échelles, 30 cm
 3-Kant Lineal, 5 Teilungen, 30 cm

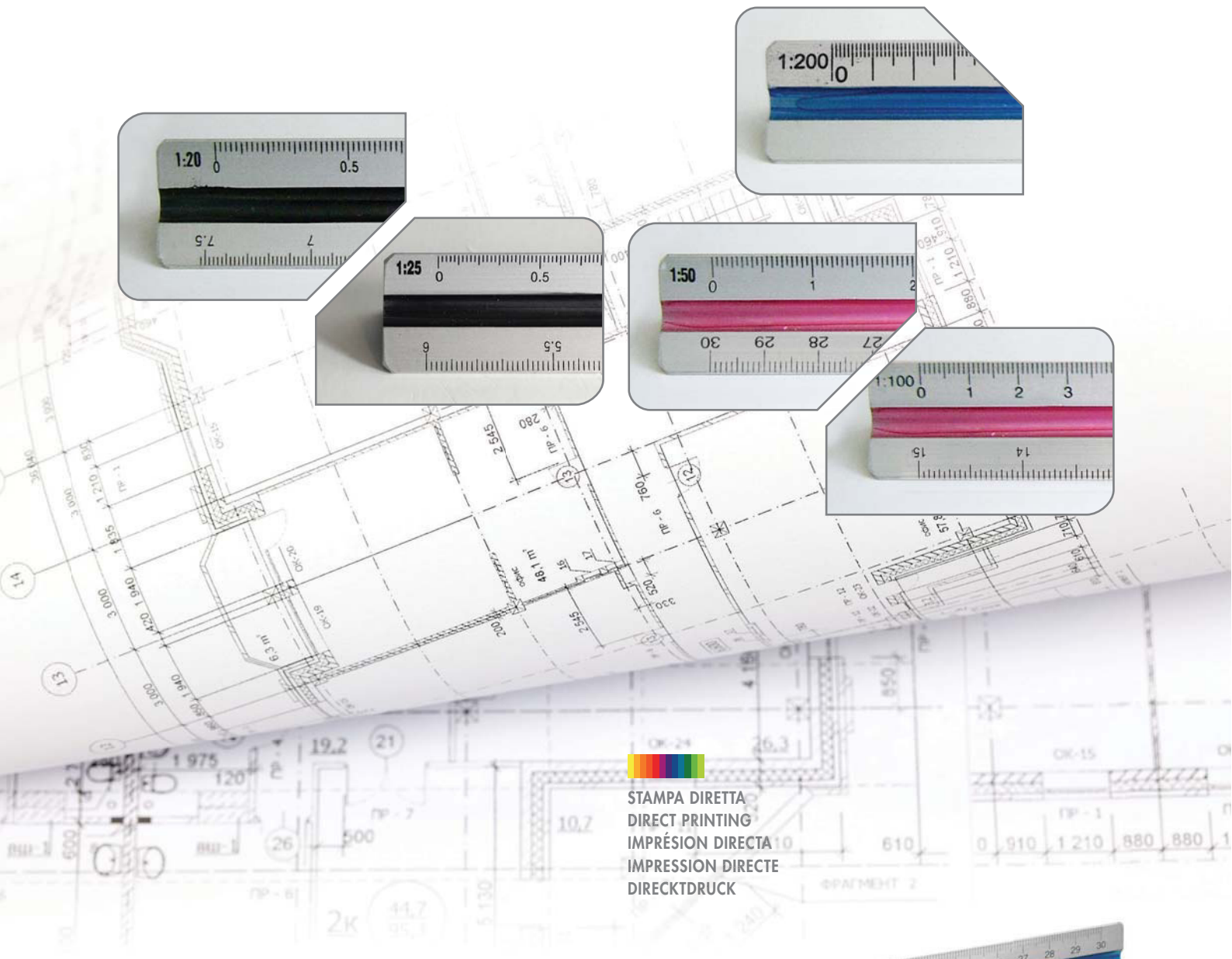

STAMPA DIRETTA
 DIRECT PRINTING
 IMPRESSION DIRECTE
 IMPRESSION DIRECTE
 DIRECKTDRUCK





| Ref. | L | |  |
|--------------|-------|------------|---|
| 60186 | 30 cm | 150 x 4 mm | NR. COLOR 1 |

Righelli in plastica
 Plastic rule
 Plastico
 Règles en plastique
 Kunststoff-Lineale



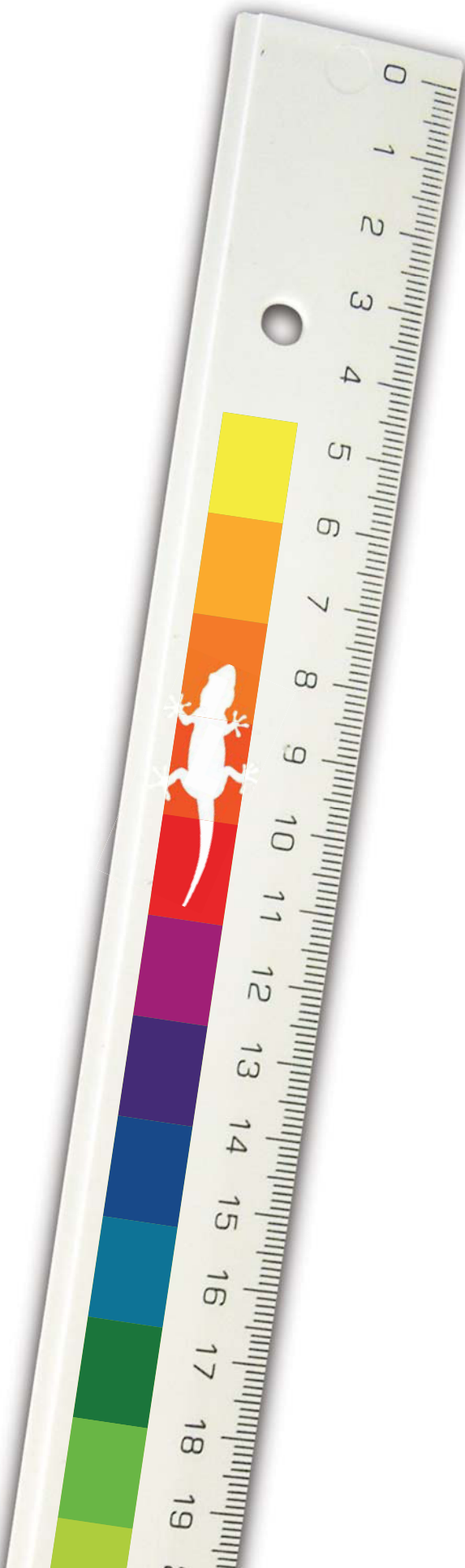

STAMPA DIRETTA
 DIRECT PRINTING
 IMPRESSION DIRECTA
 IMPRESSION DIRECTE
 DIRECKTDRUCK



| Ref. | | L x H x S |  |  |
|-------|---|-------------------|---|---|
| | | | | NR. COLOR |
| 25395 | ○ | 300 x 38 x 2,8 mm | 15 x 220 mm | 1 |
| 25396 | ● | 300 x 38 x 2,8 mm | 15 x 220 mm | 1 |
| 25398 | ● | 300 x 38 x 2,8 mm | 15 x 220 mm | 1 |
| 25399 | ● | 300 x 38 x 2,8 mm | 15 x 220 mm | 1 |
| 25400 | ● | 300 x 38 x 2,8 mm | 15 x 220 mm | 1 |



| Ref. | | L x H x S |  |  |
|-------|---|-------------------|---|---|
| | | | | NR. COLOR |
| 25410 | ○ | 300 x 30 x 2,5 mm | 14 x 210 mm | 1 |
| 25411 | ● | 300 x 30 x 2,5 mm | 14 x 210 mm | 1 |
| 25413 | ● | 300 x 30 x 2,5 mm | 14 x 210 mm | 1 |
| 25414 | ● | 300 x 30 x 2,5 mm | 14 x 210 mm | 1 |
| 25415 | ● | 300 x 30 x 2,5 mm | 14 x 210 mm | 1 |

Righelli in plastica colori fluorescenti
 Plastic bright colours
 Plastico colores fluorescentes
 Règles en plastique couleurs lumineuses
 Kunststoff-Lineale

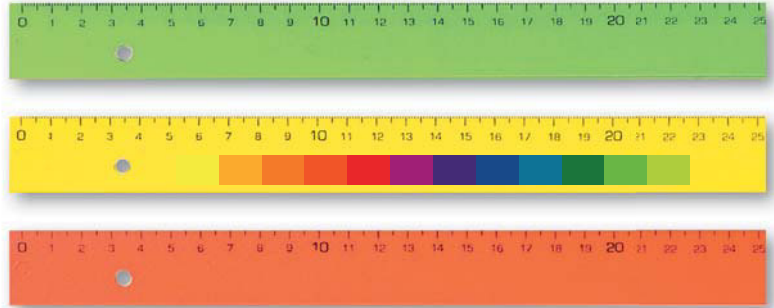

STAMPA DIRETTA
 DIRECT PRINTING
 IMPRÉSION DIRECTA
 IMPRESSION DIRECTE
 DIRECKTDRUCK

| Ref. | L x H x S | | NR. COLOR |
|-------|-------------------|-------------|-----------|
| 25450 | 300 x 30 x 2,5 mm | 11 x 195 mm | 1 |
| 25451 | 300 x 30 x 2,5 mm | 11 x 195 mm | 1 |
| 25452 | 300 x 30 x 2,5 mm | 11 x 195 mm | 1 |

Righello a ventaglio 6 in 1
 Fan-type rule 6 in 1
 Regla abanico 6 en 1
 Règles en éventail 6 en 1
 Fächer-Maßstab 6 in 1



STAMPA DIRETTA
 DIRECT PRINTING
 IMPRÉSION DIRECTA
 IMPRESSION DIRECTE
 DIRECKTDRUCK

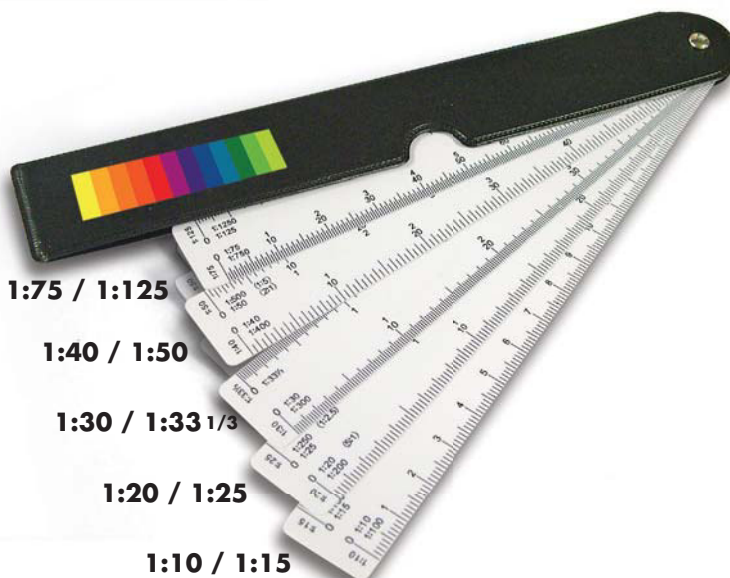

| Ref. | |
|-------|-------|
| 25391 | mm |